

IQ System Controller 3 INT - 100 A

Quick install guide

Scan the QR code for the latest quick install guide

Scansione della Guida all'installazione rapida più recente

Recherchez le dernier guide d'installation rapide

Scannen voor de nieuwste quick install guide

Procurar o Guia de Instalação Rápida mais recente

Buscar la última Guía de instalación rápida

Σάρωση για τον πιο πρόσφατο Οδηγό γρήγορης εγκατάστασης

Scannen Sie den QR-Code für die neueste Schnellinstallationsanleitung

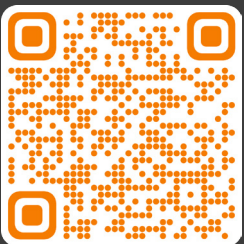

MODEL NUMBER:
SC100G-M230-3P

VERSION 1.0
MAY 2025



140-00428-01

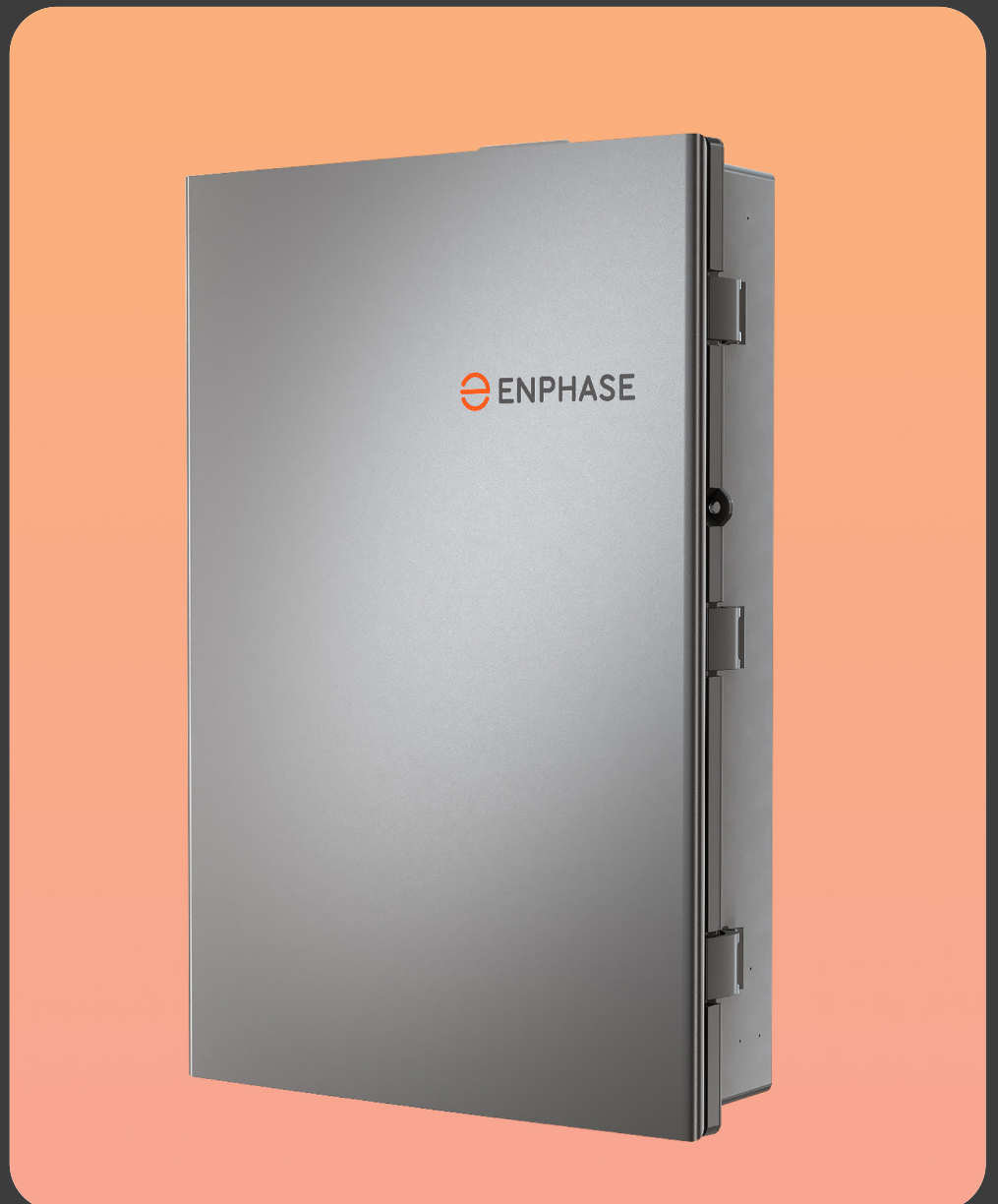

Introduction

The IQ System Controller 3 INT connects the home to the electricity grid, the IQ Battery storage system, and solar PV. It provides automatic transfer switch (ATS) functionality by automatically detecting and seamlessly transitioning the home energy system from grid power to backup power in the event of a grid failure.

It consolidates interconnection equipment and a communication gateway into a single enclosure and streamlines the grid-independent capabilities of PV and storage installations by providing a consistent, pre-wired solution.

The IQ System Controller 3 INT supports IQ7 and IQ8 Series Microinverters. It supports a maximum of 80 A grid interconnection capacity in three-phase configuration and 100 A grid interconnection capacity in single-phase configuration.

The supported earthing systems are TN-C-S, TN-S, and TT. The earthing systems that are not supported are TN-C and IT. To install the IQ System Controller 3 INT, read and follow all warnings and instructions in this guide and documents at <https://enphase.com/contact/support>.

Safety warnings are listed at the end of this guide. These instructions are not meant to be a complete explanation of how to design and install an energy storage system. All installations must comply with national and local electrical codes and standards. Only Enphase-certified installers shall install, troubleshoot, or replace the IQ System Controller 3 INT.



Table of contents

Section A -			
Mount IQ System Controller 3 INT	4	IQ System Controller 3 INT LEDs	27
Tools/additional items required	4	IQ Gateway LEDs and buttons	28
What is in the box	5	Cellular modem status LEDs	29
Step 1: Plan a location for mounting the unit	6	Safety	30
Step 2: Minimum clearance	7	Appendix A - Wiring scenarios	32
Step 3: Open the door	8	A1: System with single-phase IQ Battery and PV without neutral disconnection	33
Step 4: Mount the IQ System Controller 3 INT	9	A2: System with single-phase IQ Battery and PV with neutral disconnection and neutral breakers	34
Step 5: Drill cable entry holes	10	A3: Grid/mains and loads with neutral breaker and neutral switching	35
Step 6: Open the dead front	11	A4: Three-phase PV and single-phase IQ Battery	36
Section B - Wiring	12	A5: Grid/mains and loads without neutral breaker and with neutral switching	37
Internal view of IQ System Controller 3 INT	12	A6: Three-phase PV and IQ Battery	38
Power Terminal details	13	Revision history	39
Wiring scenarios	14	Installer notes	40-42
Additional wiring instructions	15	Installer checklist	43
Wiring sequence: Three-phase	16		
Wire control (CTRL) cable to headers	17		
Control (CTRL) wiring between system components	18		
Drain wire termination	19		
System Shutdown (SSD) Switch wiring	20		
AUX wiring	21		
AUX wiring: PV shedding, third-party PV integration, and load control	22		
Close the dead front and install the cell modem and breaker filler plate	23		
Final checks and system commissioning	25		
Operation	26		
Operation of System Shutdown (SSD)Switch	26		
Steps to activate System Shutdown (SSD) Switch	26		
Steps to de-activate System Shutdown (SSD) Switch	26		
IQ Gateway displays and controls	26		
Manual override mode	26		
Steps to activate the manual override	26		
Enphase Energy System shutdown procedure	26		
Maintenance	26		
Troubleshooting	26		

Section A - Mount IQ System Controller 3 INT

Tools/additional items required

S. NO	ITEM NAME	MINIMUM QUANTITY
1	MCB/RCD/RCBO of applicable ratings	As required
2	Conduits/Cable gland (with fittings and fitting tools) - IP55 and above (for non-rear entry systems)	As required
3	IP55 conduit ground locknut (for non-rear entry systems)	1
4	M6 pilot bit	1
5	Wrench	1
6	Adjustable wrench	1
7	Torque wrench (up to 10 N m)	1
8	Level gauge	1
9	4 mm hex bit and multi-bit screwdriver	2
10	Conductor insulation stripper	1
11	Electrician's hole saw, punch set, or step drill	1 set
12	Stud finder	1
13	Drill and drill bit extender	As required
14	M6 lag bolts or screw 80 mm long (depending on wall construction) for each wall-mount bracket	2
15	Control cable*	As required
16	Phillips size #2 screwdriver	1
17	2.5 mm, 3 mm, 6 mm, and 7.5 mm slotted screwdrivers	1 each
18	Duspol voltage tester	1

* For Enphase-qualified control cable, refer to <https://link.enphase.com/control-cable-table-eu>.

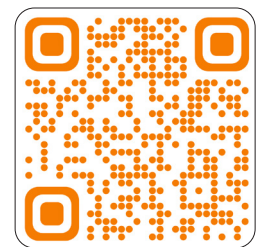

Section A - Mount IQ System Controller 3 INT

What is in the box

S. NO	ITEM NAME	QUANTITY
1	IQ System Controller 3 INT - 100 A	1
2	System Shutdown (SSD) Switch	1
3	Wiring kit	1
4	Control (CTRL) connector (one spare, one pre-installed)	2
5	Control (CTRL) connector with resistor (one spare, one pre-installed)	2
6	Mobile Connect cell modem	1
7	Quick install guide	1
8	Cell modem cable	1

IQ System Controller 3 INT

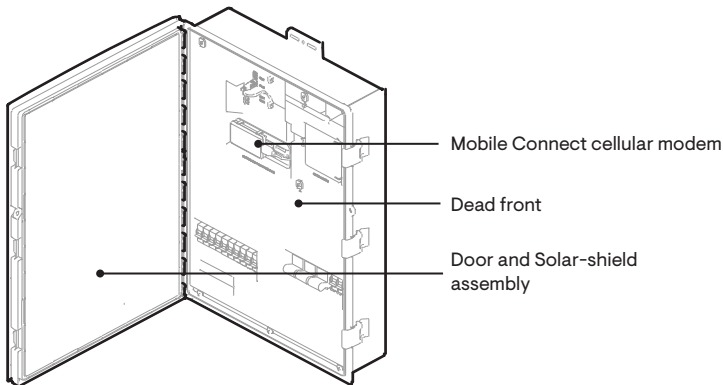

Mobile Connect cellular modem
(preinstalled in IQ System Controller 3 INT)



CELLMODEM-07-INT-05

Quick install guide



System Shutdown (SSD) Switch

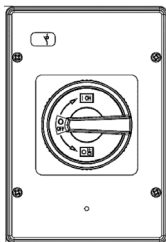

Control connector

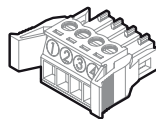

Control connector with resistor

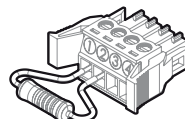

Section A - Mount IQ System Controller 3 INT

Step 1:

Plan a location for mounting the unit



- IQ System Controller 3 INT is IP55-rated and can be mounted both indoors and outdoors. Install the unit where it is not exposed to direct rainfall.
- Install this product where cables from PV, incoming mains, and batteries are easily accessible and can be terminated at the IQ System Controller 3 INT.



- The product operates within an ambient temperature range from -40°C to 50°C*.
- Do not install this product in a place where it is directly exposed to sunlight.
- Do not install the product in a dusty environment.



- This product is designed to be installed only on the wall. Do not install this product on the ground.
- The mounting surface must be able to support 15.2 kg.
- Follow all local standards and regulations while choosing a location for IQ System Controller 3 INT.

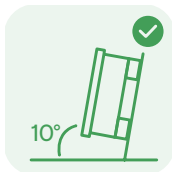

- Do not install the product on the ceiling. The unit must be accessible.
- Do not install the product on a wall with a slope of more than 10° from vertical.
- The product should be installed upright. Do not install the product tilting forward.



- This product must not be installed at altitudes above 2,000 m.
- In flood-prone areas, ensure that the clearance from the ground is sufficient to avoid water ingress.

 **NOTE:** The IQ System Controller 3 INT weighs 15.2 kg and will require two people to align and mount the unit. A keyhole opening is provided in the attached point for ease of mounting.

*When operated at 100 A in single-phase configuration the operating ambient temperature range is -40°C to 45°C.

Section A - Mount IQ System Controller 3 INT

Step 2: Minimum clearance

This product must be installed with clearances, as shown in the figure.
Follow all local standards and regulations related to mounting an electrical distribution panel.
If using side power cable/Ethernet cable entry, pre-drill conduit holes before installing.

✓ NOTE: Clearances indicated are after the installation.

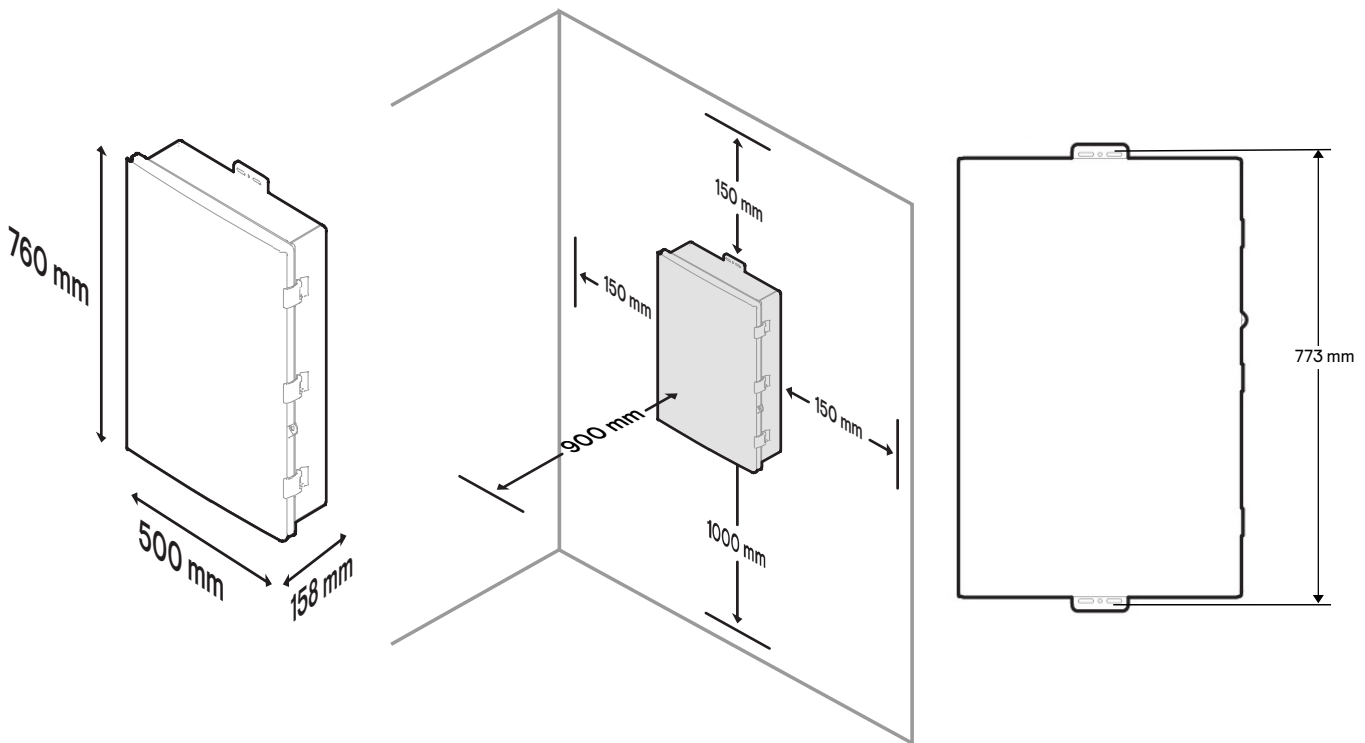

*The minimum clearance to be maintained in front of the IQ System Controller is 600 mm.

Section A - Mount IQ System Controller 3 INT

Step 3: Open the door

Install the IQ System Controller 3 INT as per the instructions below. Please note the following before installing:

- IQ System Controller 3 INT weighs 15.2 kg and will require two people to lift and align the unit.
- Remove the door and keep it aside safely for ease of installation.

 **WARNING:** Risk of injury and equipment damage. Avoid dropping the IQ System Controller 3 INT. Doing so may create a hazard, cause serious injury, and/or damage the equipment.

 **WARNING:** Do Not open the door beyond 90°.

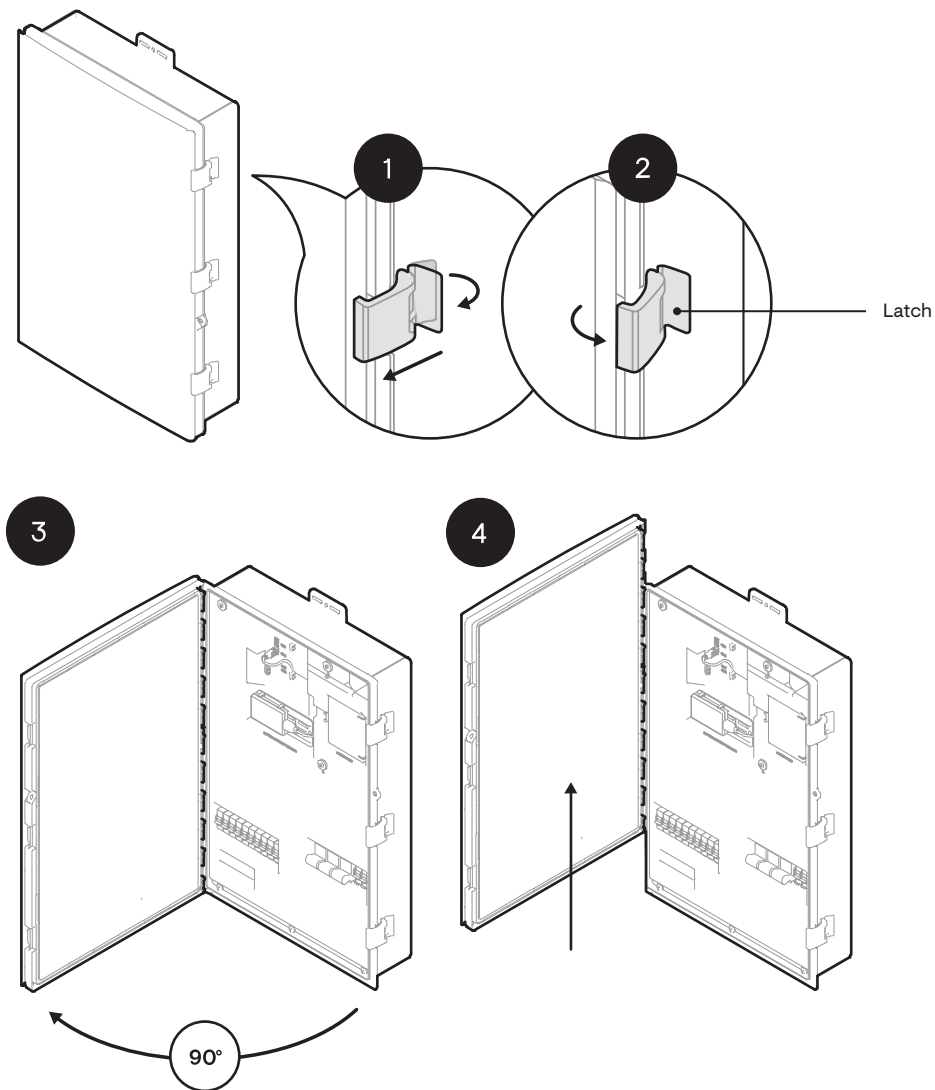

Section A - Mount IQ System Controller 3 INT

Step 4: Mount the IQ System Controller 3 INT

 **WARNING:** Risk of electric shock. To maintain the warranty, do not modify the dead front other than to remove or replace filler plates as needed.

Please note the following:

- When mounting to a timber stud wall, place the IQ System Controller 3 INT on the wall so that the mounting holes at the middle of the mounting tabs are aligned with the centre of the stud. Mark the top centre hole for predrilling and keep IQ System Controller 3 INT aside safely.
- Drill holes in the wall.
- Use washers and suitable fasteners to mount the system control on the wall. Use a level gauge to horizontally align the IQ System Controller 3 INT enclosure.

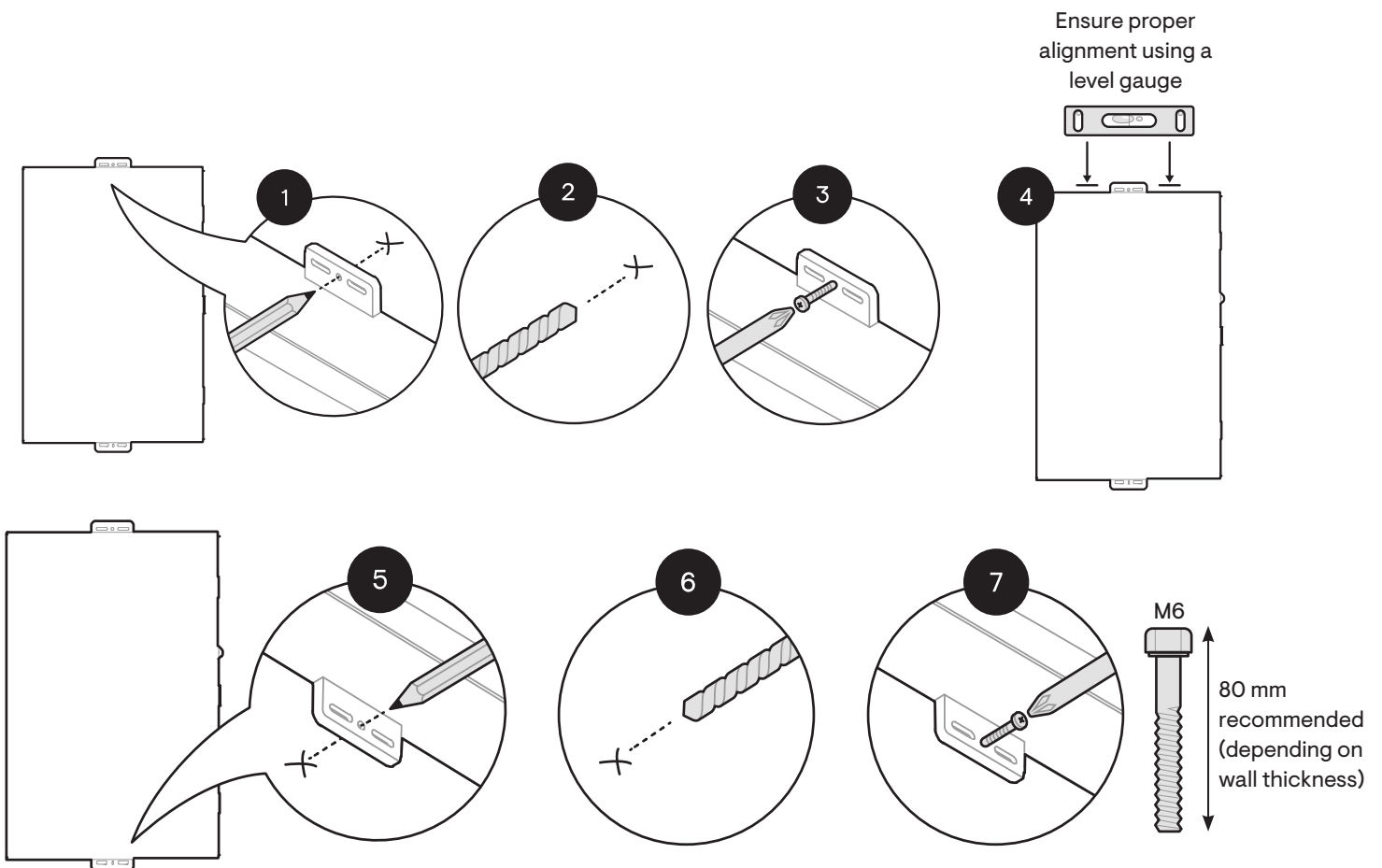

 **NOTE:** Use a drill bit extender for better access to mounting holes during installation.

Section A - Mount IQ System Controller 3 INT

Step 5: Drill cable entry holes

Drill conduit entry/cable gland holes as needed and install conduit grounding lugs or cable glands in each opening before mounting IQ System Controller 3 INT on the wall. Be sure to reseal unused conduit entry holes with sealing plugs.

There are options for conduit entry from the bottom, the two sides, and the rear. Maximum sizes for the bottom and rear conduit/cable gland are also shown below. The drill points are marked on IQ System Controller 3 INT.



WARNING: Do not drill the conduit holes once the unit is mounted on the wall. This will result in the exposure of circuit boards to heavy dust, resulting in potential shorts. Conduit holes are to be marked separately on the unit and wall for drilling.

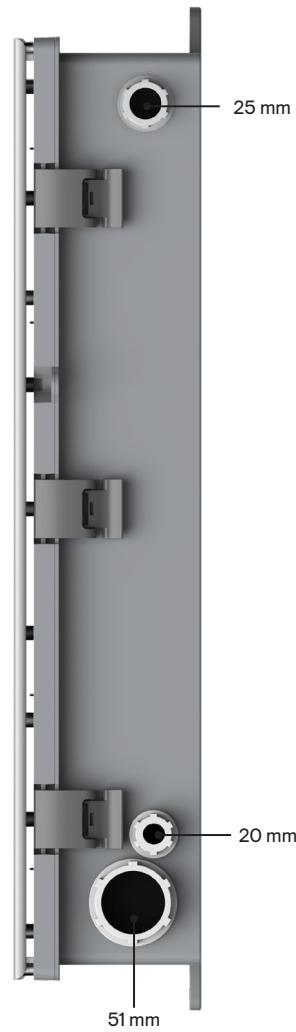

Right side view

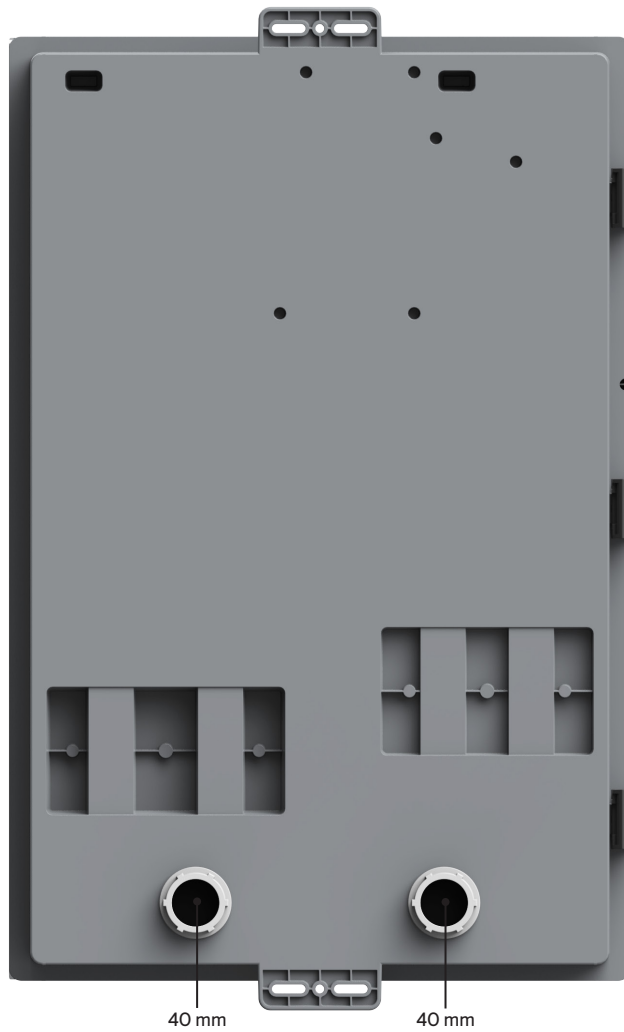

Back view



Left side view

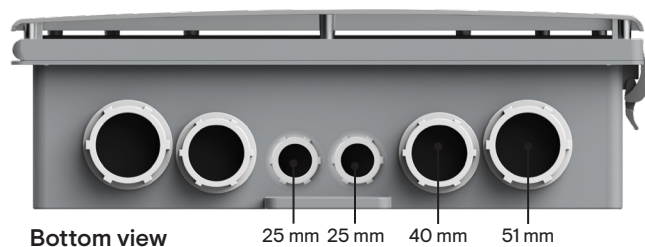

Bottom view



NOTE: Dimensions in the images indicate the diameter of conduit drill holes. Consider an additional 10 mm as cable gland thickness.

Section A - Mount IQ System Controller 3 INT

Step 6: Open the dead front

Before removing the dead front, ensure the IQ System Controller 3 INT is completely de-energized.

 **WARNING:** Risk of equipment damage and electrocution. Do not wire the IQ System Controller 3 INT when it is energized.

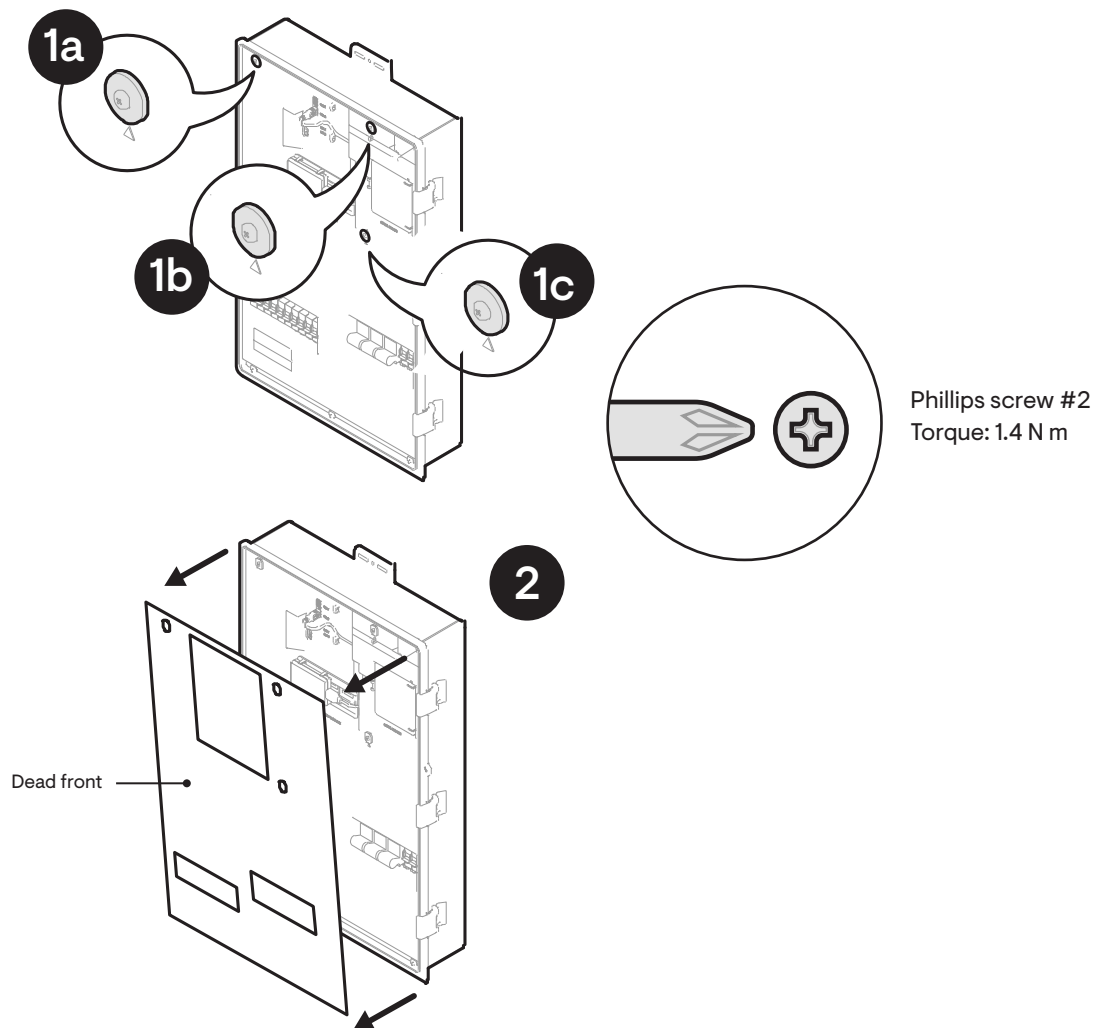

 **NOTE:** While opening the dead front later, disconnect the cell modem cable from the cell modem.

Section B - Wiring

Internal view of IQ System Controller 3 INT

IQ System Controller 3 INT with the dead front removed is shown in the image below.

DIN rails are provided to install circuit breakers. Use conductors (line, neutral, and ground/earth) and circuit breakers of suitable current rating and protection requirements according to local codes.

Refer to the wiring table, torque recommendations, and local codes for any specific local requirements before wiring the IQ System Controller 3 INT.

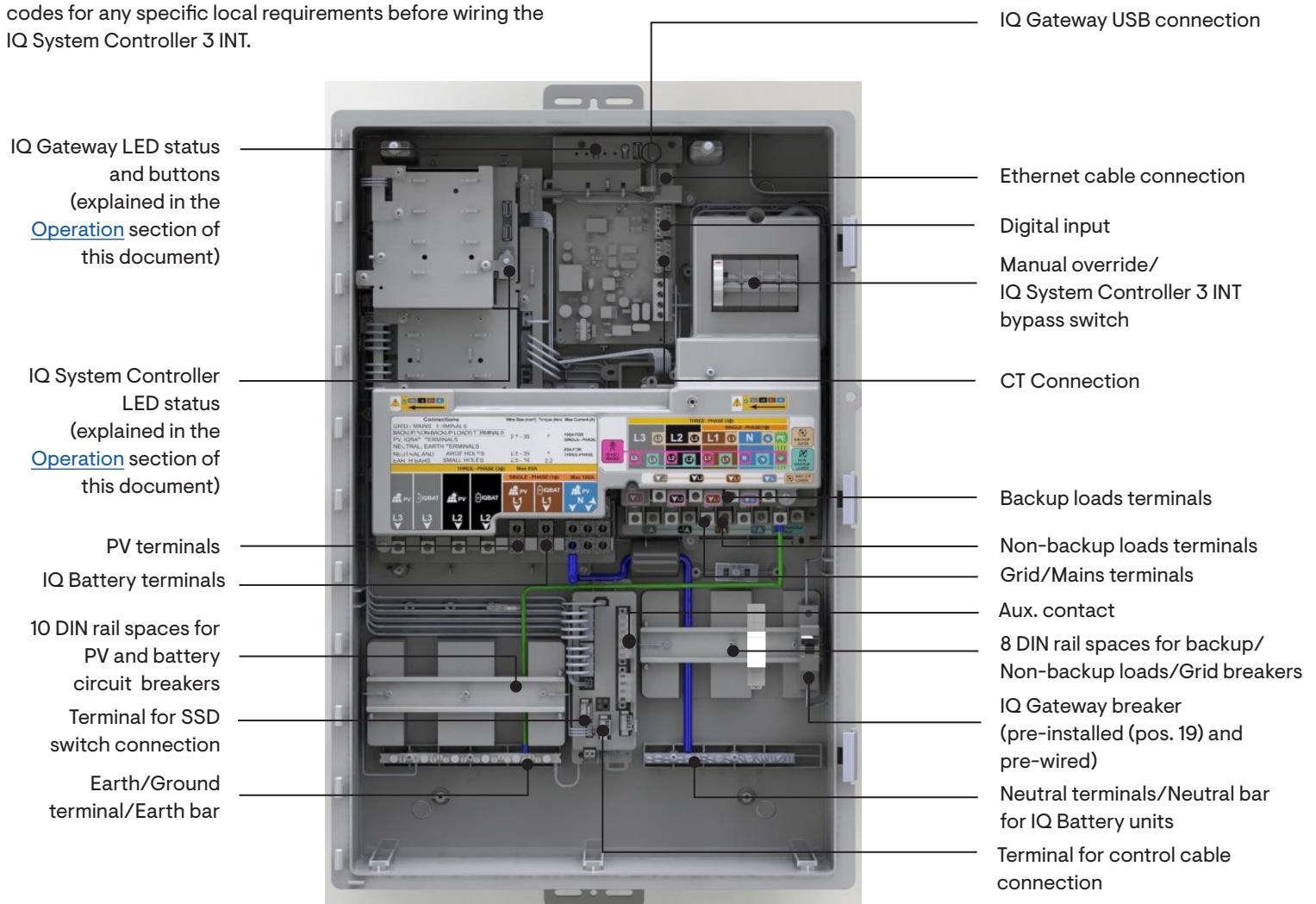



NOTE: All DIN rails are earthed.

Section B - Wiring

Power terminal details

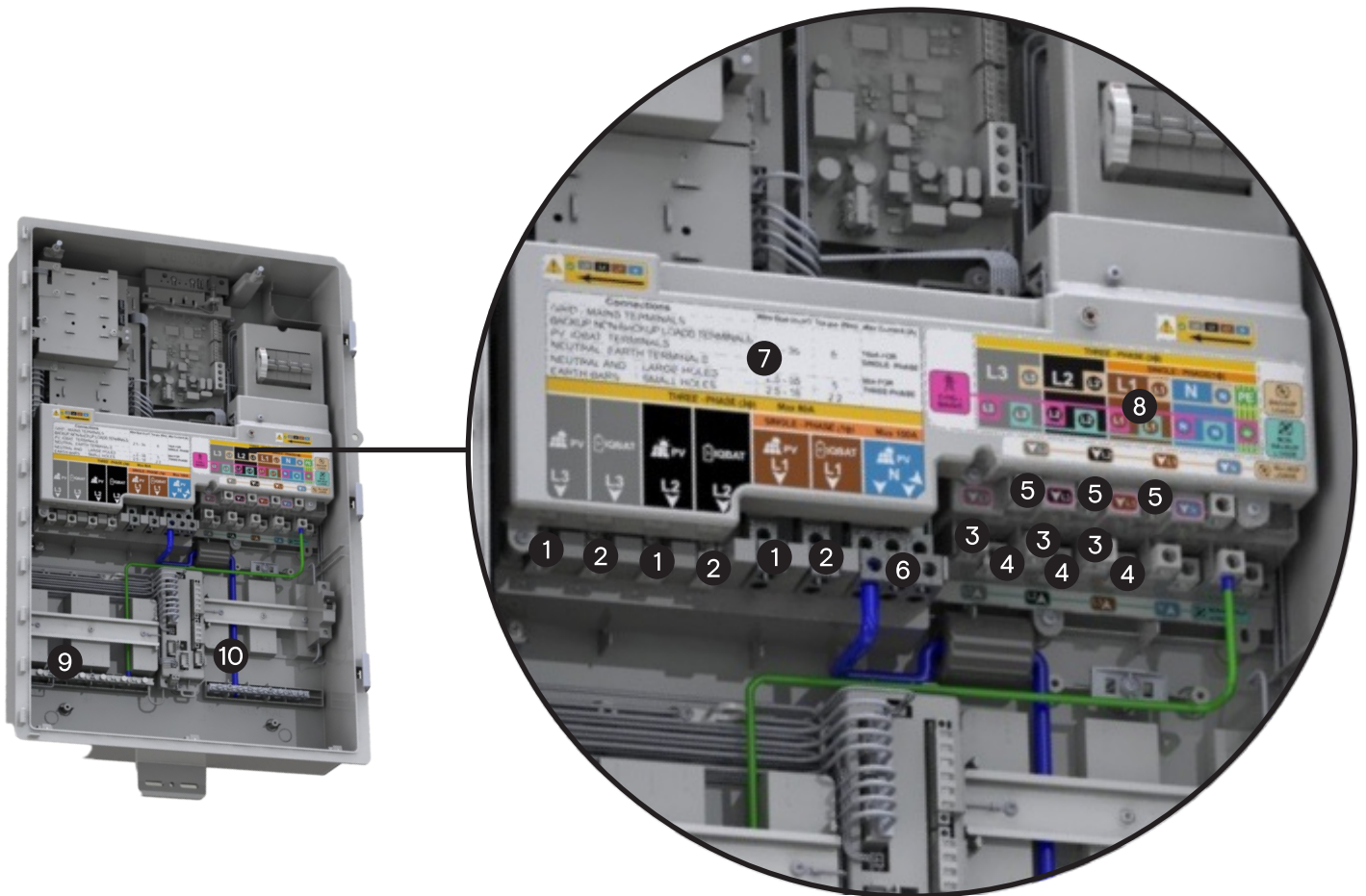
- 1 PV terminals
- 2 IQ Battery terminals
- 3 Grid/Mains terminals
- 4 Non-backup load terminals
- 5 Backup load terminals
- 6 PV neutral terminal
- 7 DER termination label
- 8 Main relay label
- 9 Earth bar
- 10 Neutral bar/Battery neutral terminal



 **WARNING:** Ensure that the phase conductors are connected to their respective terminals. The sequence of phase terminals in the unit is L3-L2-L1 from left to right.



WARNING: PV neutral must be wired to breaker before landing on neutral lugs. Battery neutral must be wired to neutral bar













Section B - Wiring

APPLICABLE REGIONS	WIRING SCENARIOS	GRID NEUTRAL DISCONNECTION IN BACKUP MODE	NEUTRAL CIRCUIT BREAKER REQUIRED	COMPATIBLE BATTERY MODEL	WIRING SCENARIO DESTINATION
UK	Single-phase system	No	No	IQBATTERY-5P-1P-ROW/ IQBATTERY-5P-3P-INT	A1
Europe (2-pole breaker)	Single-phase system	Yes	Yes	IQBATTERY-5P-1P-INT	A2
Europe (3-pole breaker)	Three-phase grid/ mains and loads	Yes	No	IQBATTERY-5P-3P-INT	A3
	Three-phase PV and Battery	Yes	No	IQBATTERY-5P-3P-INT	A4
Europe (4-pole breaker)	Three-phase grid/ mains and loads	Yes	Yes	IQBATTERY-5P-3P-INT	A5
	Three-phase PV and Battery	Yes	Yes	IQBATTERY-5P-3P-INT	A6

Supported earthing systems:

The supported earthing systems are TN-C-S, TN-S, and TT.
The earthing systems that are not supported are TN-C and IT.

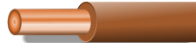
Cable colours (indicative)

Wire type	IEC	IND, ZAF
AC three-phase (L1)		
AC three-phase (L2)		
AC three-phase (L3)		
Neutral (N)		
Protective earth (PE) Ground (GND)		
Single-phase (L)		

Section B - Wiring

Additional wiring instructions

WARNING: Ensure that the phase conductors are connected to their respective terminals. The sequence of phase terminals in the unit is L3-L2-L1 from left to right.

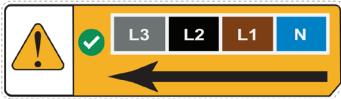

1. Do not change the IQ Gateway breaker position from slot number 19 (indicated in dead front).
2. PV, IQ Battery, load, and mains breakers/RCDs/RCBOs should be sized as per local requirements and cable sizes used on site. These are not supplied with the IQ System Controller 3 INT.
3. Circuit breakers/RCDs/RCBOs for PV, IQ Batteries, mains, and non-backup/backup loads are not supplied with IQ System Controller 3 INT and must be purchased separately.
4. Supported cable sizes, torque, and strip lengths for various connections are as follows:

CONNECTIONS	TOOL/DRIVE	CONDUCTOR SIZES (mm ²)	TORQUE (N m)	STRIP LENGTH (mm)
Grid/Load/PV/Battery terminals	4 mm hex	2.5–35	6	12
Neutral and earth/ground bar large holes	Slotted 7.5 mm	2.5–35	5	10
Neutral and earth/ground bar small holes	Slotted 6 mm	2.5–16	2.2	10

- NOTE:** A local earth electrode is necessary to ensure safe operation during backup scenarios. Follow local electrical regulations and best practices.
- NOTE:** IQ Gateway circuit breaker is pre-installed and pre-wired along with IQ System Controller 3 INT. Use this breaker to power cycle the IQ Gateway only if required for troubleshooting. Do not change the circuit breaker position from slot number 19 (indicated in the dead front).
- NOTE:** Size the conductors and circuit breakers according to local electrical codes. Ensure that the wires connected to the breakers are tightened and torqued as recommended by the breaker manufacturer.
- NOTE:** For sites/systems with one PV circuit and one battery circuit, the use of RCBO is recommended to house all disconnection devices inside the IQ System Controller 3 INT.

Critical electrical wiring checks

1. Measure the grid circuit breaker voltage:
 - Check the voltage between L and N on each terminal at the incoming side of the grid circuit breaker using a voltmeter.
 - Ensure the voltage reads 230 VAC (195–253 V) for L1-N, L2-N, and L3-N.
2. Close the grid circuit breakers.
3. Check the phase rotation at the IQ System Controller's grid terminals.
 - The phase rotation should be in the right/clockwise direction.
 - Use a voltage tester like Duspol® with L and R indicators.
 - Place the L1 probe on the L1 grid terminal and the L2 probe on the L2 grid terminal of the IQ System Controller.
 - The R indicator will illuminate if the phase rotation is correct.
 - Check L1-L2, L2-L3, and L3-L1. The R indicator should illuminate for all checks. The Duspol® voltage tester is shown.
4. Ensure the battery/PV/backup/non-backup load line and neutral conductors are connected to the correct terminals on the IQ System Controller.
5. Close the battery/PV/backup/non-backup load circuit breakers and ensure DER and backup/non-backup load voltages are in sync with the grid voltages.

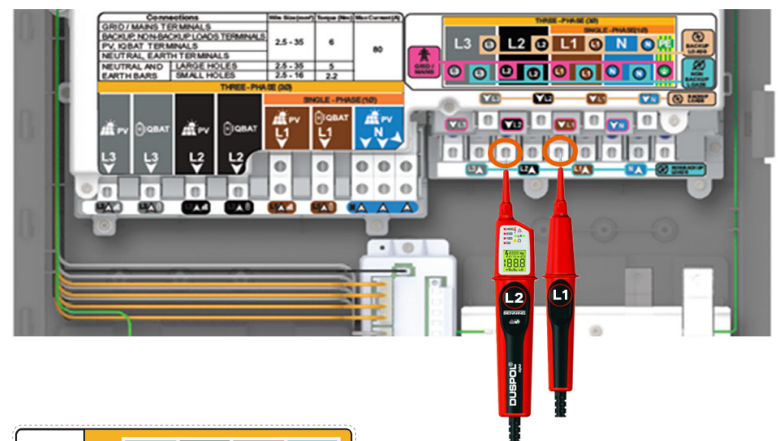

- NOTE:** In the IQ System Controller, L1 is on the right side. Hold the L2 probe of the Duspol tester (with the display) in the left hand.

Section B - Wiring

Wiring sequence: Three-phase

⚠ WARNING: Ensure that the phase conductors are connected to their respective terminals. The sequence of phase terminals in the unit is L3-L2-L1 from left to right.

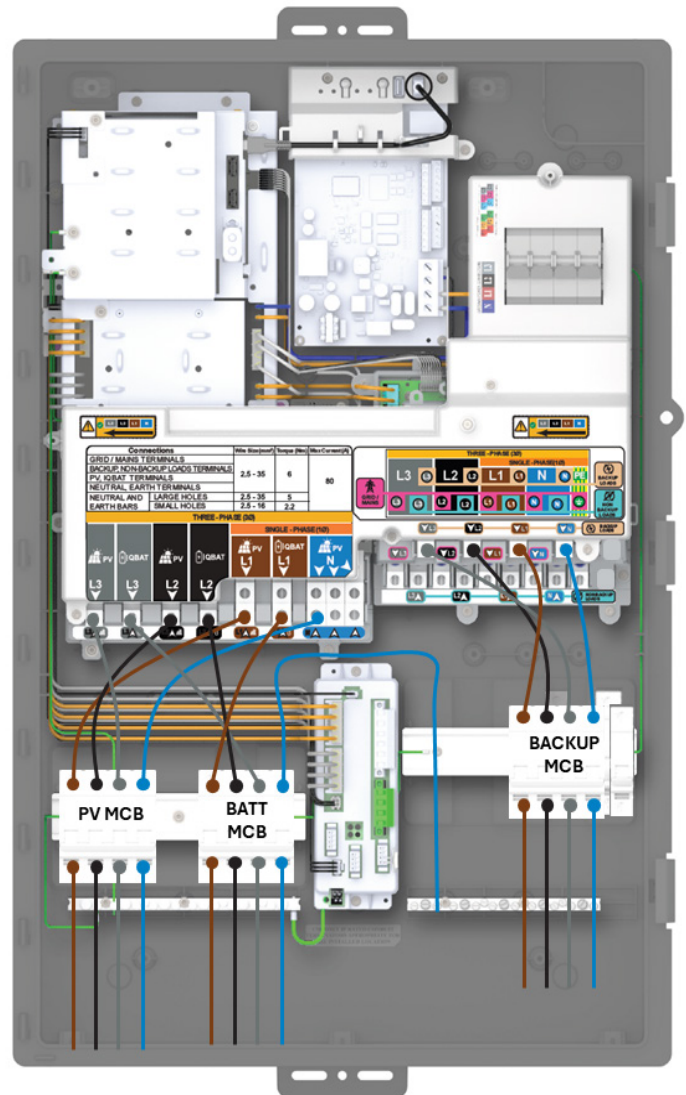
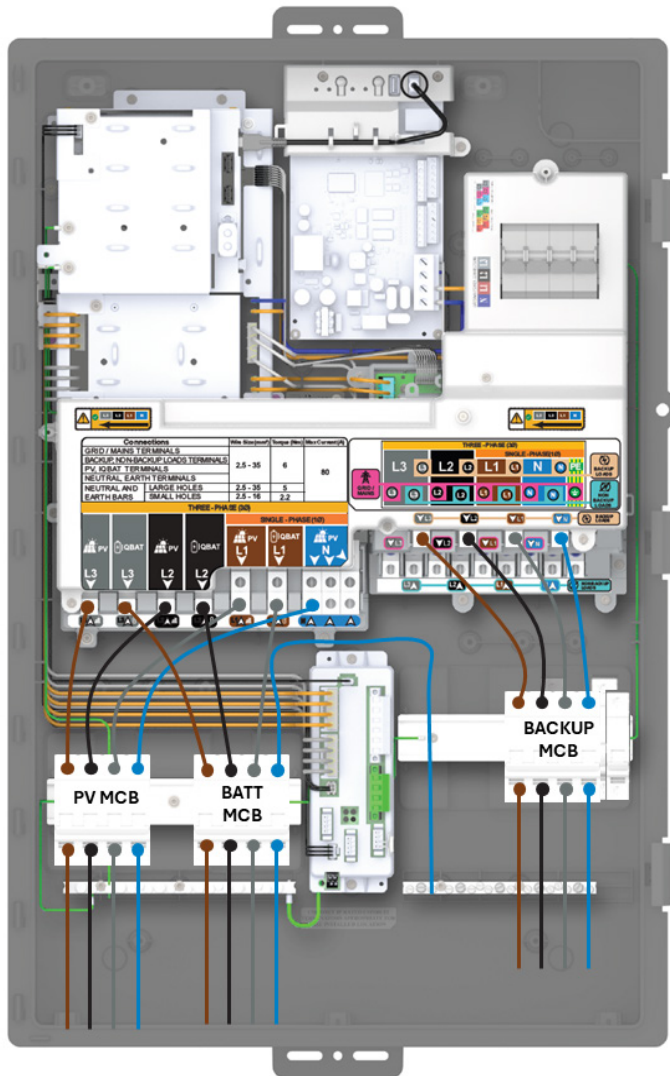

Section B - Wiring

Wire control (CTRL) cable to headers

IQ System Controller 3 INT supports only wired control connections with IQ Battery.

NOTE: Use Enphase-recommended cables and headers, and refer to local codes for any specific local requirements.

* For Enphase-recommended control cables, refer to <https://link.enphase.com/control-cable-table-eu>.

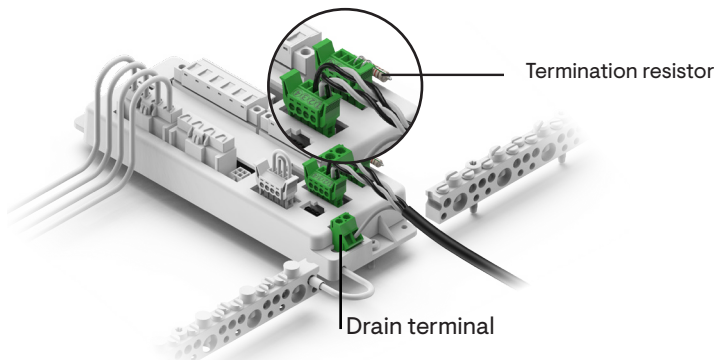
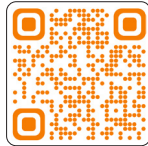

Scenario 1: When IQ System Controller 3 INT is a termination node for the control network (at the end of the control cable bus), use a connector with a termination resistor in the terminal port.

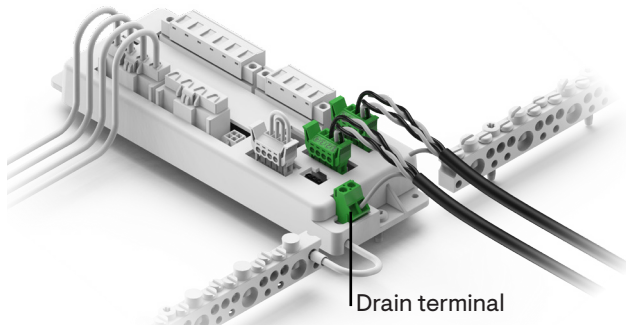

Scenario 2: When IQ System Controller 3 INT is not a terminal node for the control network (in the middle of the control cable loop), terminate the control wires on both connectors.

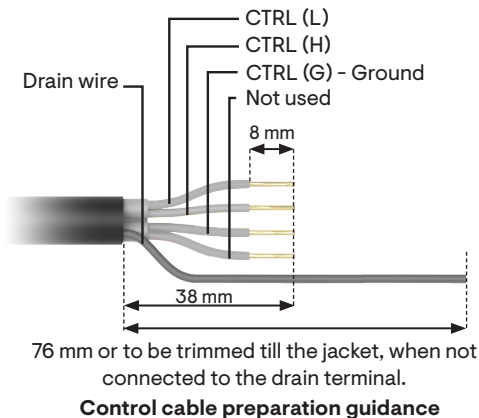

TIP: Before pulling the cable through any conduit, perform continuity checks and label each end of all the wires with small coloured clips or stickers (with the same numerals as on the headers). This will enable easy identification of wires and avoid miswiring.

- Control wiring colours are indicative and might differ for different manufacturers.
- The control cable must be stripped to the recommended dimensions as indicated above and then connected to the header.

WARNING: Failure to follow wiring guidance will result in the system being unable to detect devices, leading to commissioning and operation failures.

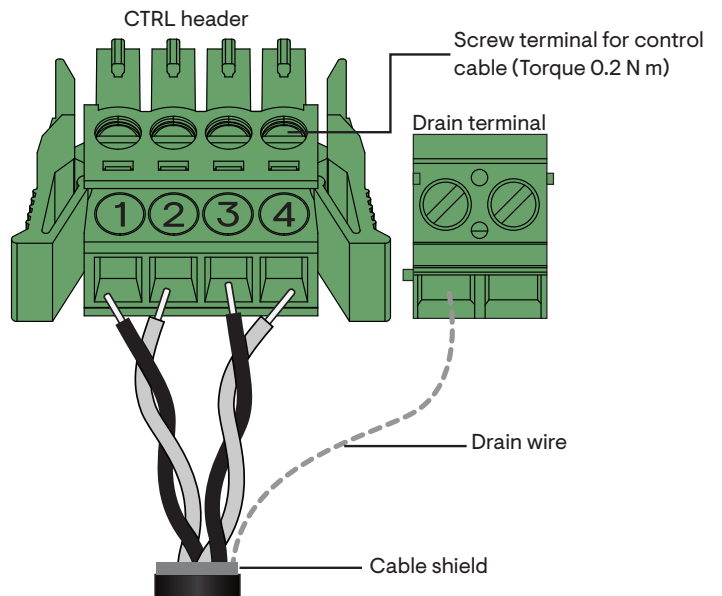

CTRL HEADER NUMBERS	CTRL SIGNALS
Screw terminal 1	CTRL L - LOW
Screw terminal 2	CTRL H - HIGH
Screw terminal 3	CTRL G - GROUND
Screw terminal 4	Not used

NOTE: To avoid mis-wiring, note the wire colour as well as the number on the wire cores.

- Ensure that both ends of the CTRL cable twisted pair wires are inserted into the header, as shown above. Confirm this by performing a continuity check between CTRL header screw terminals on both ends of the CTRL cable section.
- Connect the drain wire to the drain terminal only at one end of a CTRL cable. Do not connect drain wires at both ends of a CTRL cable. Follow the guidance in the following section.

Section B - Wiring

Control (CTRL) wiring between system components

Control wiring guidance for the Enphase Energy System:
Refer to the following wiring sequences to understand the position of the header with termination resistor, wiring order, and drain wire termination location.

✔ **NOTE:** Ensure the following guidelines are followed to avoid failures during system commissioning:

- One header with a termination resistor should be installed on each component at the end of the control network.
- The drain wire should only be terminated on one end of the control wiring between system components.
- It is recommended to terminate the drain wire at the component from which the control wiring for the section is initiated.
- The same conduits can be used for power and control wire routing with Enphase-recommended cables.

The following are three indicative wiring sequences:

Sequence 1: IQ System Controller 3 INT → IQ Battery(s) 5P

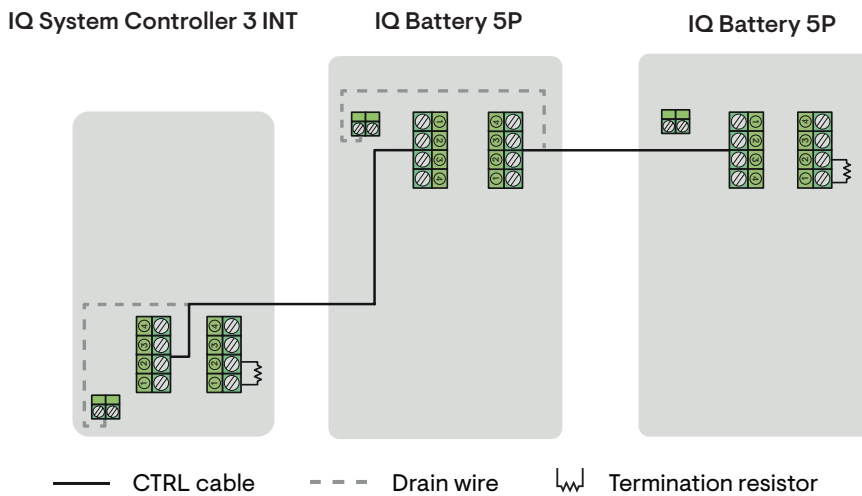

Sequence 2: IQ Battery(s) 5P → IQ System Controller 3 INT

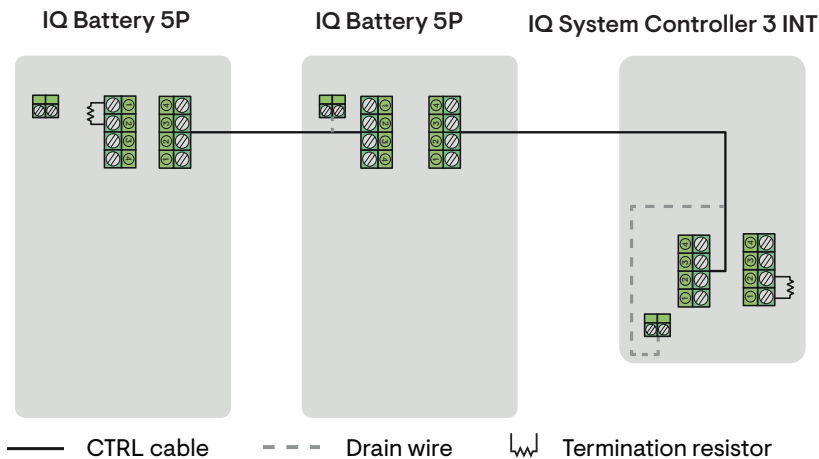

Section B - Wiring

Sequence 3: IQ Battery(s) 5P → IQ System Controller 3 INT → IQ Battery(s) 5P

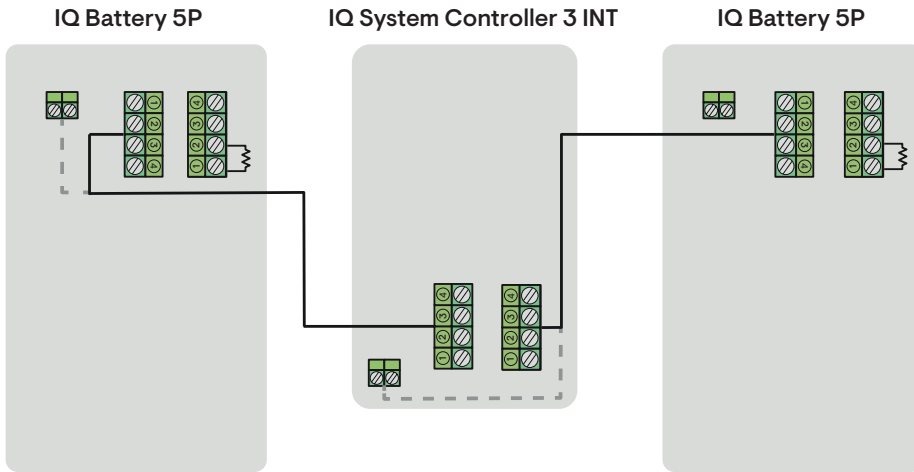

— CTRL cable - - - Drain wire Termination resistor

NOTE: The total length of CTRL wiring across the system should not exceed 100 meters to ensure optimal system performance.

Here is a table providing termination resistor locations for the above sequences:

CONTROL WIRING SEQUENCE	TERMINATION RESISTOR LOCATION
Sequence 1: IQ System Controller 3 INT → IQ Battery(s) 5P	<ul style="list-style-type: none"> • IQ System Controller 3 INT • Last IQ Battery 5P in the battery daisy chain
Sequence 2: IQ Battery(s) 5P → IQ System Controller 3 INT	<ul style="list-style-type: none"> • First IQ Battery 5P in the battery daisy chain • IQ System Controller 3 INT
Sequence 3: IQ Battery(s) 5P → IQ System Controller 3 INT → IQ Battery(s) 5P	<ul style="list-style-type: none"> • First IQ Battery 5P • Last IQ Battery 5P

Drain wire termination

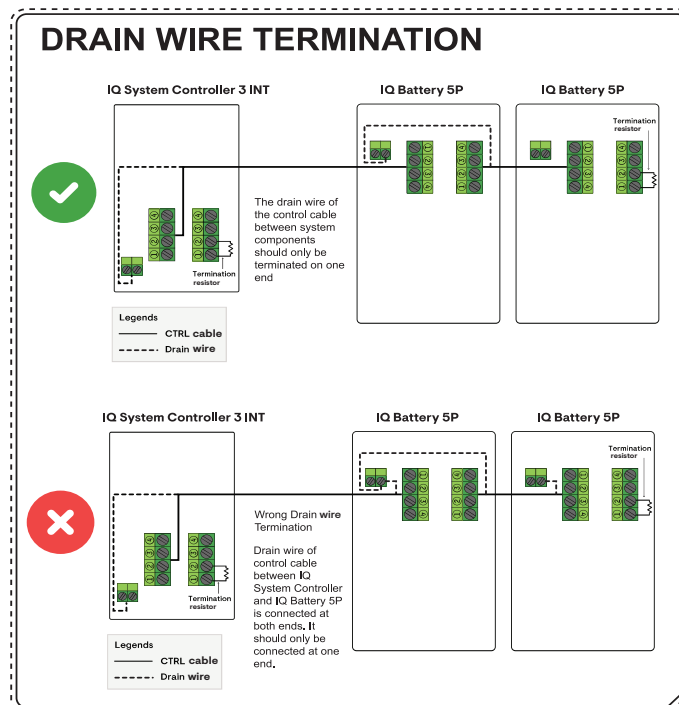

Section B - Wiring

System Shutdown (SSD) Switch wiring

⚠ WARNING: Risk of equipment damage. Do not wire the IQ System Controller 3 INT when it is energized.

⚠ WARNING: Wire the SSD before powering ON the system. Do not activate the SSD (turn the SSD to the OFF position) before commissioning is complete. While commissioning, the SSD Switch must be in the ON position.

Any system using the IQ System Controller 3 INT requires a System Shutdown (SSD) Switch. The SSD Switch, when used in conjunction with PV and battery circuit breakers, disconnects all PV panels and batteries from the home to ensure the safety of maintenance technicians. When the system shutdown sequence outlined in this section as follows, the Enphase Energy System will be shut down, and the home will be connected to the grid.

The SSD Switch is a double-pole single-throw lockable switch. The SSD Switch should be placed in a readily accessible location outdoors and wired to IQ System Controller 3 INT. The maximum distance between the SSD Switch and the IQ System Controller is 60 meters.

The SSD port in IQ System Controller 3 INT uses a detachable header that must be wired to the SSD Switch. By default, the header is shorted. You must remove the wires shorting the header and connect the wires from the SSD Switch.

Follow the instructions below for SSD Switch installation:

- Open the front face of the SSD enclosure by loosening the four screws on the front face.
- Use wires of cross section 0.5–1.5 mm² to connect the SSD Switch to the header.
- Draw the wires into the SSD Switch enclosure.
- Use 1.2 N m torque to terminate wires to the SSD Switch.
- Use an appropriately sized ferrule to terminate the wire in the header.
- Use 0.2 N m torque to connect the wire to the header.
- Wire terminal 1 and terminal 2 of the SSD Switch to pins 1 and 2 of the header, respectively.
- Wire terminal 3 and terminal 4 of the SSD Switch to pins 3 and 4 of the header, respectively.
- Secure the switch to the rear plate of the enclosure using push-fit latches.
- There are four mounting points on the back plate of the enclosure to mount the SSD Switch enclosure.
- The type of screw is to be determined by the installer based on the SSD Switch mounting location.
- Use 1.0 N m torque to secure the front cover to the back plate of the enclosure.

- Ensure that the switch is in the “ON” position.
- Plug the header onto the Input Output Board (IOB) board.

SSD header-switch wiring sequence:

SSD HEADER	SSD SWITCH TERMINAL
Screw terminal 1	Terminal 1
Screw terminal 2	Terminal 2
Screw terminal 3	Terminal 3
Screw terminal 4	Terminal 4

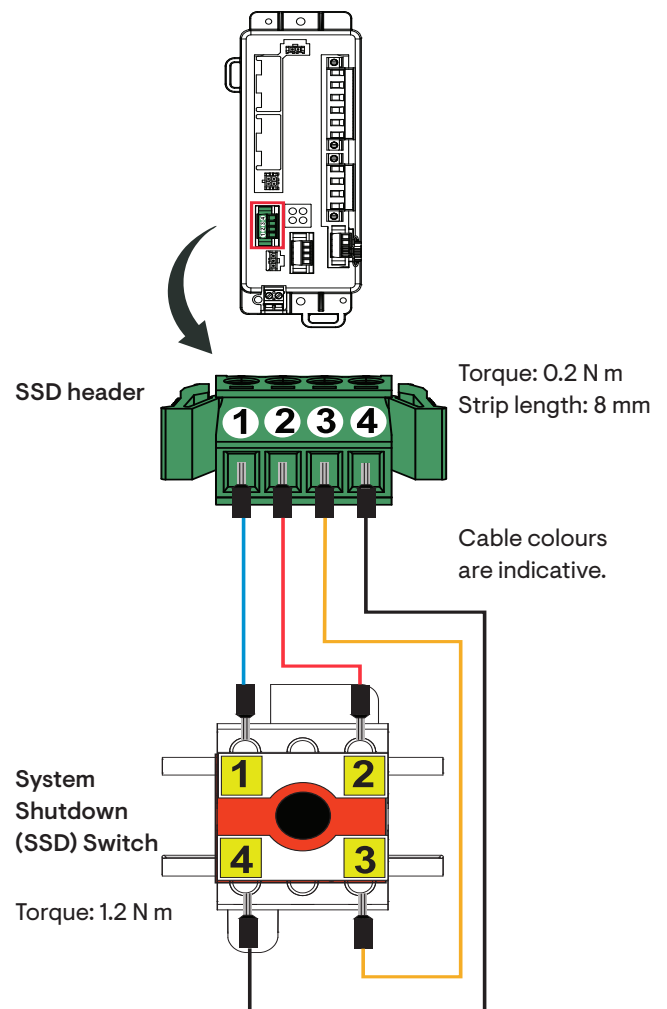

Section B - Wiring

AUX wiring

IQ System Controller 3 INT has 4 auxiliary contacts for PV shedding, third-party PV integration, and load-shedding functionalities. The two NC and NO contacts are rated for a maximum of 1 A at 230 VAC RMS or 24 VDC.

TOOL/DRIVE	CONDUCTOR SIZES (mm ²)	TORQUE (N m)	STRIP LENGTH (mm)
M3	1-2.5	0.5	7-8

The contacts are removable for ease of wiring. Use an M3 screwdriver to loosen the attachment screw and remove the header. Loosen the cable fixing screws to attach the cable. Tighten the cable fixing screws to a torque of 0.5 N.m. Plug back the header and tighten the attachment screws to a torque of 0.5 N.m.

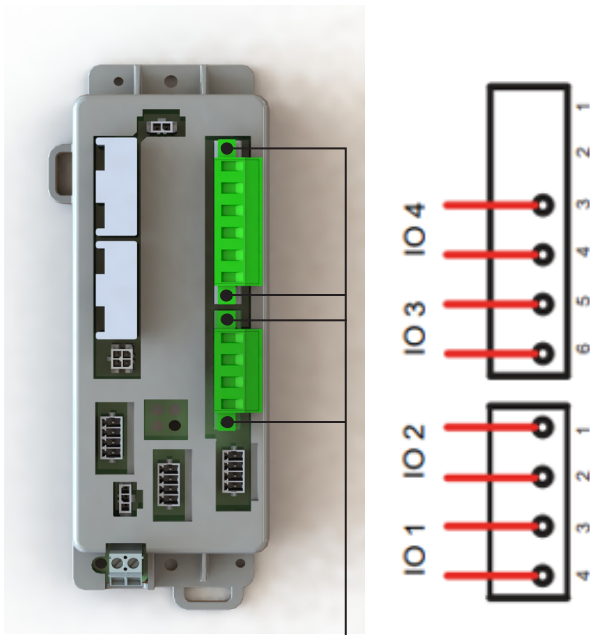

Attachment screws

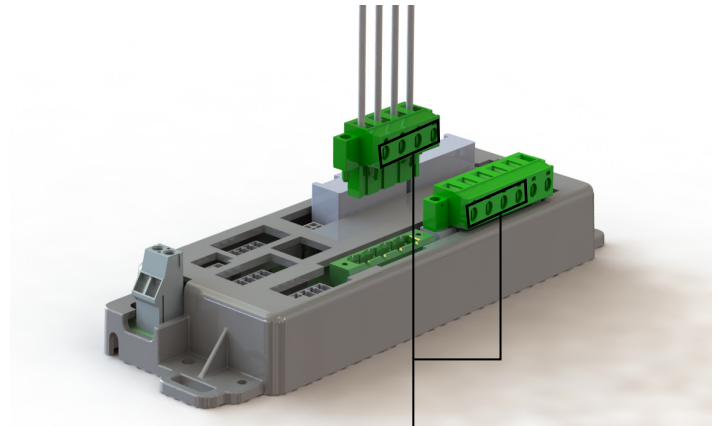

Cable fixing screws

IO1 and IO2 act as NC1 and NC2. IO3 and IO4 act as NO1 and NO2. Functionalities of the aux contacts can be configured using the Enphase Installer App as shown below.

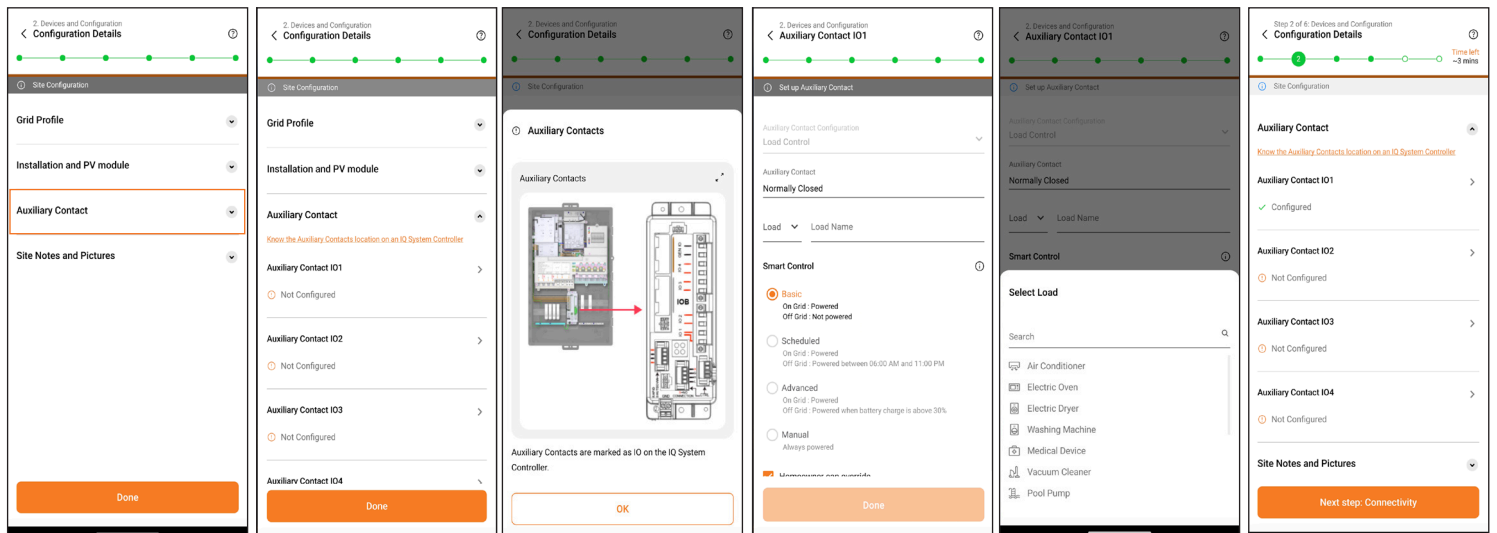

Section B - Wiring

AUX wiring:

PV shedding, third-party PV integration, and load control

PV shedding

PV shedding allows oversized PV systems with IQ7 and S Series Microinverters to be installed with grid-forming batteries and IQ System Controller 3 INT.

PV microinverters operate normally when the system is on grid. When the system goes off-grid, the auxiliary contacts disconnect the PV circuit to avoid overloading the IQ Battery 5P.

✔ **NOTE:** PV shedding is required when the total continuous power (kVA) from PV on a phase exceeds 150% of continuous power (kVA) from the batteries on that phase. In such scenarios, PV shedding can be used to shed PV microinverter circuits to reduce the PV's continuous power when the system is off-grid.

Load control

In off-grid state low-priority loads with high power requirements may deplete energy storage. Auxiliary contacts can be used to shed these large loads to help maintain energy in the storage system.

Third-party PV inverter integration

IQ System Controller 3 INT allows integration of third-party string inverter to Enphase Energy System. In the on-grid condition, the string inverter feeds the loads and charges the IQ Battery. In the off-grid condition, at a preset SoC level of the IQ Battery, the string inverter will be disconnected using the contactor. The string inverter will be re-connected once the SoC drops lower than the preset level. Refer to the technical brief in the documentation centre for more information.

Contactor selection

- A 25 A contactor is required for PV circuit shedding.
- Contactors used for load shedding need to be sized in accordance with load rating.
- A Normally Open (NO) type contactor must be used in both cases.
- For PV shedding, an AC-7a or AC-7b rated contactor can be used.
- For load control, 230 V 50 Hz rated contactors that conform with the IEC EN 61095 utilization categories must be used.

Wiring for PV shedding

Step 1: Connect the PV shedding circuit breaker to the NO contactor and connect the microinverter circuit to the output of the NO contactor as shown

Step 2: Connect the control voltage cable for the NO contactor to the IO1 pin terminal on the IO Board. Note the pin number to the program during commissioning.

Step 3: Connect the reference terminal of the IO pin from Step 2 to the IQ Gateway circuit breaker, backup load circuit breaker, or backup panel.

Wiring for load control must use a contactor to break the supply to non-essential loads.

For more details, refer to the commissioning guide and tech briefs.

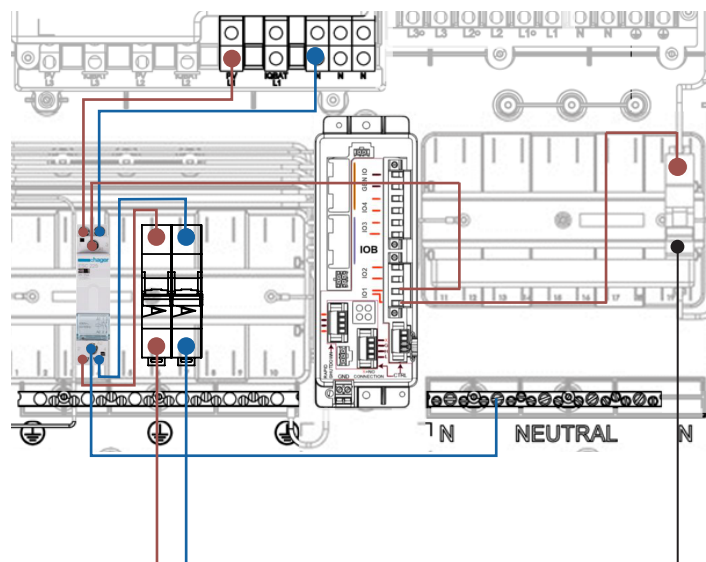

From third-party PV circuit

IQ Gateway circuit breaker

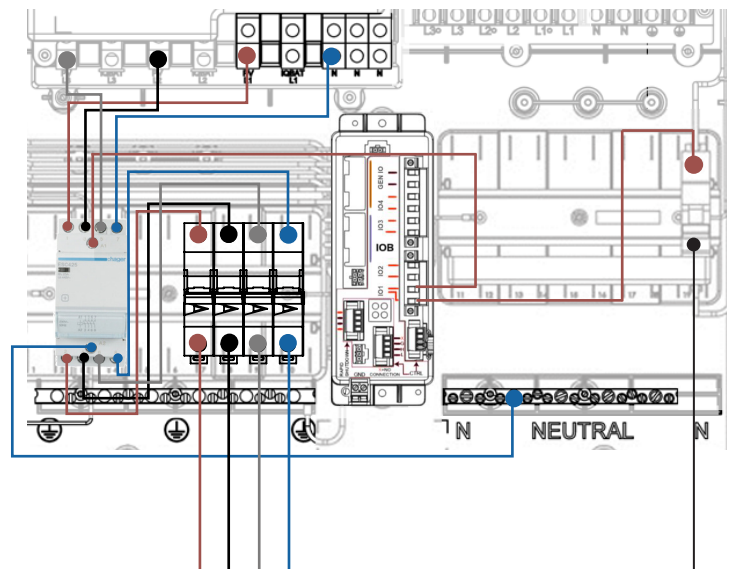

From third-party PV circuit

IQ Gateway circuit breaker

Close the dead front and install cell modem and breaker filler plate

 **WARNING:** Before energizing, ensure that all IQ System Controller 3 INT connections are properly installed, and conductors terminated.

 **WARNING:** Risk of equipment damage. Ensure that no conductors are pinched when fixing the dead front onto IQ System Controller 3 INT.

1. Slide the dead front to the fixing slots.
2. Fix the dead front using the three screws and tighten them using a Phillips screwdriver #2.
3. Connect the USB-A side of the cell modem cable to the IQ Gateway USB port.
4. Attach the breaker filler plate to the bottom part of the mains circuit breaker cutout, as shown in the image below.

1

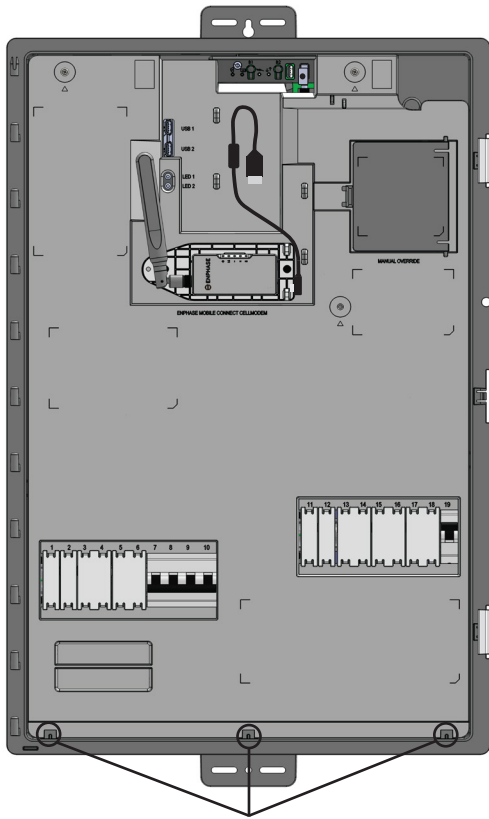

2

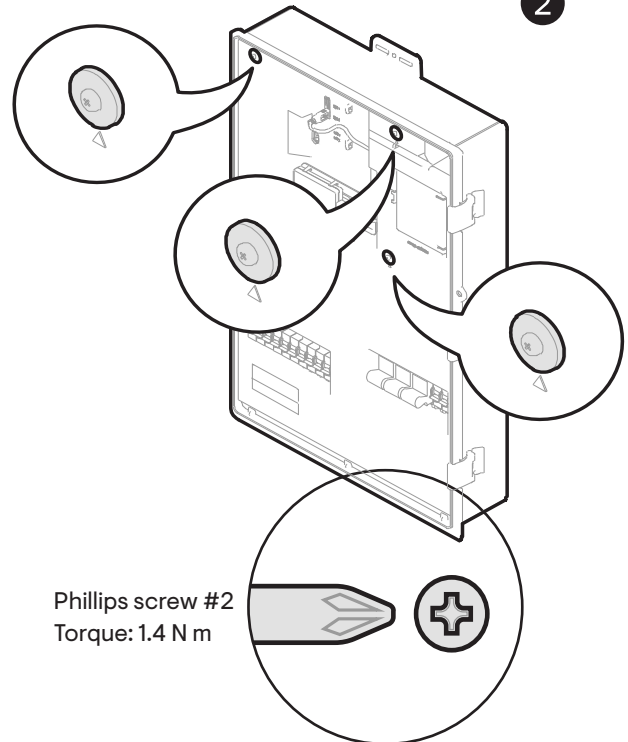

 **NOTE:** Circuit breakers for solar, IQ Battery, mains, and non-backup/backup loads are not part of the supply scope with IQ System Controller 3 INT and must be purchased separately. Breaker configurations shown in the above images are indicative.

 **WARNING:** Ensure that the wires are not pinched while re-attaching the dead front.

Close the dead front and install cell modem and breaker filler plate

✔ **NOTE:** The cellular connection is only intended as a backup communication channel. Primary internet connectivity must be provided using the homeowner's Ethernet/Wi-Fi. Cellular connectivity is subject to network operator coverage and signal strength.

The IQ System Controller 3 INT is packaged with the Mobile Connect cellular modem - CELLMODEM-M1-06-AT-05 or CELLMODEM-07-INT-05.

3

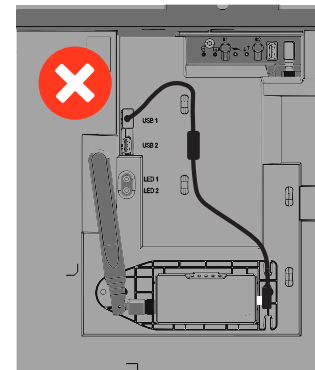
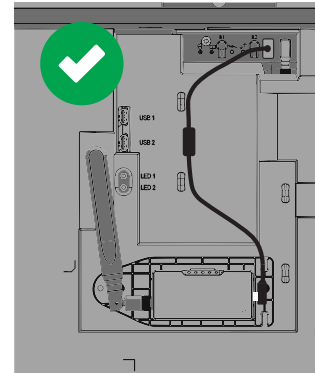
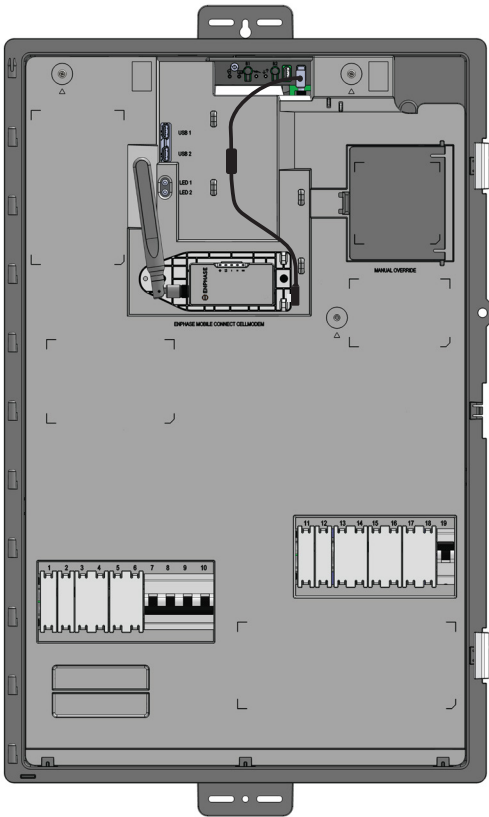

4

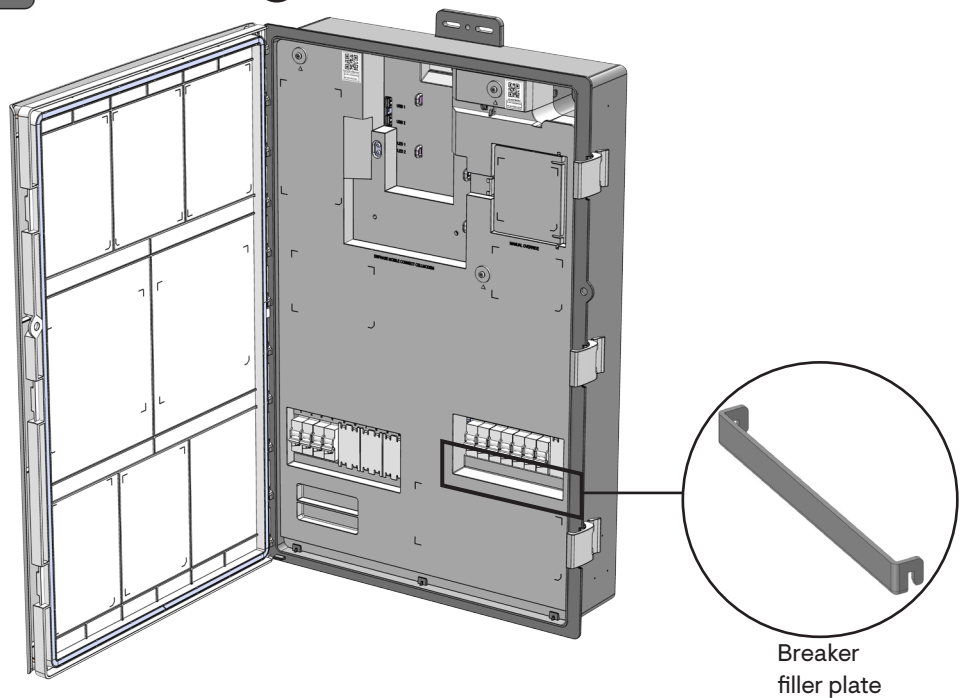

Final checks and system commissioning

Internet connectivity for IQ Gateway

Internet connectivity is a must-have for all features of the product to work as intended and to ensure that the product receives the latest software upgrades with relevant features and improvements.

Ensure Ethernet and/or Wi-Fi connections are configured during commissioning. The IQ Gateway will automatically select the network option with the best connection. Cellular is available only as a backup connection when Wi-Fi and Ethernet-based internet connections are lost. Cellular should not be relied on as the default connection method.

Energize IQ System Controller 3 INT

 **NOTE:** Before closing the unit, take photos of the completed wiring in the IQ System Controller 3 INT, IQ Battery 5P, and main distribution board.

Ensure that all conduit junctions and cable entry points are secure and properly sealed.

Arrange the CTRL and power cables neatly inside the unit.

 **DANGER:** Risk of electric shock. There are many potential sources of voltage. Check any IQ Battery, PV, or other generation source for voltage.

 **DANGER:** Risk of electric shock. The terminals of IQ System Controller 3 INT is exposed and can be energized if any of the sources are ON. Observe caution while checking system functioning.

 **WARNING:** Risk of equipment damage. Do not wire the IQ System Controller 3 INT when it is energized.

 **NOTE:** If you are not commissioning the system, you must ensure that the DC switches on all IQ Batteries are turned off to avoid the depletion of charge on the IQ Batteries.

- A. You must ensure that all electrical circuits external to IQ System Controller 3 INT are completed, safely terminated, and connected to the correct phase and neutral connection before energizing the IQ System Controller 3 INT.
- B. If you plan to commission the system, follow the instructions in the Enphase Installer App for energizing the IQ System Controller 3 INT.
- C. Measure the grid circuit breaker voltage:
 - Check the voltage between L and N on each terminal at the incoming side of the grid circuit breaker using a voltmeter.
 - Ensure the voltage reads 230 VAC (195–253 V) for L1-N, L2-N, and L3-N.
- D. Close the grid circuit breakers.
- E. Check the phase rotation at the IQ System Controller's grid terminals.
 - The phase rotation should be in the right/clockwise direction.
 - Use a voltage tester like Duspol® with L and R indicators.
 - Place the L1 probe on the L1 grid terminal and the L2 probe on the L2 grid terminal of the IQ System Controller.
 - The R indicator will illuminate if the phase rotation is correct.
 - Check L1-L2, L2-L3, and L3-L1. The R indicator should illuminate for all checks. The Duspol® voltage tester is shown.
- F. Ensure the battery/PV/backup/non-backup load line and neutral conductors are connected to the correct terminals on the IQ System Controller.
- G. Close the battery/PV/backup/non-backup load circuit breakers and ensure DER and backup/non-backup load voltages are in sync with the grid voltages.

Configure and activate

- Use the Enphase Installer App to commission the IQ System Controller 3 INT.
- If you do not see the IQ System Controller 3 INT information in the Enphase Installer App, check that the IQ Gateway AP mode light is green. If not, press the AP mode button and follow the instructions in the Enphase Installer App to connect the phone to the IQ Gateway's Wi-Fi network.
- Once connected to the IQ Gateway, refer to the Enphase Installer App help topics for more information.
- Once the system is commissioned, close and secure the door of the IQ System Controller 3 INT.

Operation

Operation of System

Shutdown (SSD) Switch

Activation/De-activation is to be carried out only after commissioning is complete.

If System Shutdown is activated accidentally by turning the SSD Switch OFF before commissioning, call Enphase Support.

Steps to activate System Shutdown (SSD) Switch

1. Turn the SSD Switch to the “OFF” position.
2. Press the DC switches on all IQ Battery 5P units to turn them “OFF”.
3. Turn the PV circuit breakers in the IQ System Controller 3 INT to the “OFF” position.
4. Turn the IQ Battery 5P circuit breakers in IQ System Controller 3 INT to the “OFF” position.
5. Wait for one minute. Use a multimeter to measure AC voltage on the PV and IQ Battery AC terminals and ensure they are safe. A low ~20 VDC voltage may be seen on the AC wires leading to PV and IQ Battery units. This is expected and is to enable the system to perform Sunlight Jump Start.

Steps to de-activate System Shutdown (SSD) Switch

1. Turn the SSD Switch to the “ON” position.
2. Turn the PV circuit breakers in the IQ System Controller 3 INT to the “ON” position.
3. Turn the IQ Battery 5P circuit breakers in IQ System Controller 3 INT to the “ON” position.
4. Press the DC switch on all IQ Battery 5P units to turn them “ON”.

IQ Gateway display and controls

Track system installation progress with the Enphase Installer App. The LEDs on the IQ Gateway PCB (printed circuit board) are solid green when a function is enabled or performing as expected, flashing when an operation is in progress, or solid red when troubleshooting with the Enphase Installer App is required. Refer to the IQ Gateway LED and buttons quick reference guide label on the door to know more about all the LED states.

Maintenance

IQ System Controller 3 INT does not require scheduled preventative maintenance. Ensure that the unit is connected to the internet and clear of debris or moisture.

To clean the external surfaces of the unit, use a soft cloth. Do not use cleaning solvents or chemicals.

Troubleshooting

If you have any questions about troubleshooting your system, please contact Enphase Support at <https://enphase.com/contact/support>.

Manual override mode

In the event of an emergency/unit failure, follow the instructions on the manual override switch cover to enable or disable manual override mode. By enabling manual override mode, your system will bypass the IQ Batteries and PV, and your system will become grid-tied. You should only perform these steps in the event of an emergency or if you have been instructed to do so by Enphase Support.

Steps to activate the manual override

1. Turn off the DC switches on all IQ Batteries.
2. Switch off all IQ Battery circuit breakers.
3. Switch off all PV circuit breakers.
4. Push the lever to open the manual override cover.
5. Set the manual override isolator to the “active” position.



WARNING: Setting the manual override to the “active” position without the above steps can damage the equipment. If activated correctly, manual overriding bypasses the IQ System Controller 3 INT and disconnects the PV and IQ Battery from the grid and the home loads.

Enphase Energy System shutdown procedure

1. Turn OFF the DC switches of all IQ Batteries.
2. Turn the System Shutdown Switch to the OFF position.
3. IQ Battery circuit breaker(s) and PV circuit breaker(s) in IQ System Controller 3 INT.
4. Turn OFF the mains circuit breaker in IQ System Controller 3 INT (if present) and turn OFF the incoming grid supply.
5. Turn OFF the backup and non-backup loads circuit breaker in IQ System Controller 3 INT.
6. Ensure that the LEDs on IQ Microinverters, IQ Batteries, and IQ System Controller 3 INT are off.
7. Remove the dead front and use a multimeter to measure the AC voltage on all the following terminals – PV, IQ Battery, mains, and load. Ensure no voltage is detected on any of these terminals.
8. Close and secure the dead front and the door.

IQ System Controller 3 INT LEDs

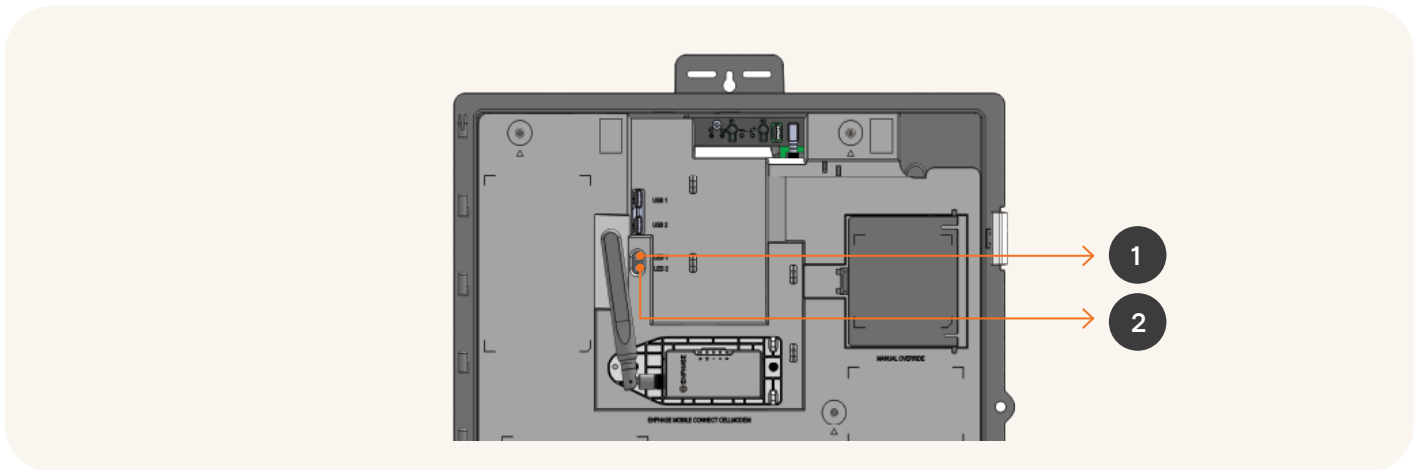

1 LED 1

LED COLOUR	STATE	DESCRIPTION
=====	Off	Not operating
— — —	Flashing green	Switched on; booting
—————	Solid green	Operational
— — —	Flashing red	Firmware upgrade
—————	Solid red	Error
— — —	Flashing blue	Operational; cannot detect any IQ Battery
—————	Solid blue	Operational; cannot detect at least one IQ Battery
— — —	Flashing yellow	Performing state of charge recovery
—————	Solid yellow	Off-grid

2 LED 2

LED COLOUR	STATE	DESCRIPTION
=====	Off	Not operating
— — —	Flashing green	Switched On; booting
—————	Solid green	Operational; on-grid
— — —	Flashing blue	Synchronizing to grid
—————	Solid blue	Off-grid
—————	Solid red	In system shutdown or manual override mode

IQ Gateway LEDs and buttons

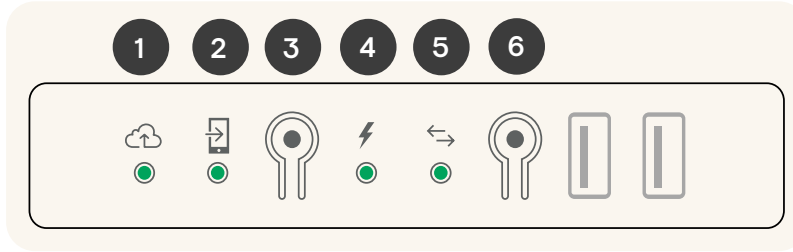

1 NETWORK COMMUNICATION LED

LED COLOUR	LED STATUS	EVENT
	Flashing green	Connecting to EIP or the Wi-Fi router.
	Green	IQ Gateway is connected to the Enphase Installer Platform (EIP).
	Red	Connected to the local network only, i.e., without internet.
	Off	No network is available.

2 AP MODE LED

LED COLOUR	LED STATUS	EVENT
	Green	AP mode is enabled and the IQ Gateway Wi-Fi network is available.
	Off	AP mode is disabled. Default state unless the installer uses AP mode.

3 AP MODE BUTTON

EVENT

To be used only by the installer to configure the system.

Press to activate AP mode.

4 POWER PRODUCTION LED

LED COLOUR	LED STATUS	EVENT
	Flashing green	An upgrade of microinverters is in progress.
	Green	All microinverters are producing power.
	Red	One or more microinverters have stopped producing power.
	Flashing red	Microinverters have not yet been detected.
	Off	All microinverters have stopped producing power.

Usually red at dawn/dusk, off at night, and flashing red after IQ Gateway restarts.

5 DEVICE COMMUNICATION LED

LED COLOUR	LED STATUS	EVENT
	Flashing green	IQ Gateway is scanning for microinverters.
	Green	All microinverters are communicating.
	Red	One or more microinverters have stopped communicating.
	Off	All microinverters have stopped communicating.

Usually red at dawn and dusk, off at night.

6 DEVICE SCAN BUTTON

EVENT

To be used only by the installer to configure the system.

Press to start/stop a 15-minute scan for devices over the power line.

Cellular modem status LEDs

The modem has the following status LEDs

- Power
- Link
- Signal

The LEDs are located on the upper right side of the front panel, as shown in the diagram alongside:

The Power LED turns green when the modem is powered. After a few minutes, the Link status LED on the Cellular modem flashes to indicate a network connection. The Signal LEDs indicate signal strength, as shown in the table on the next page. No additional configuration is needed.

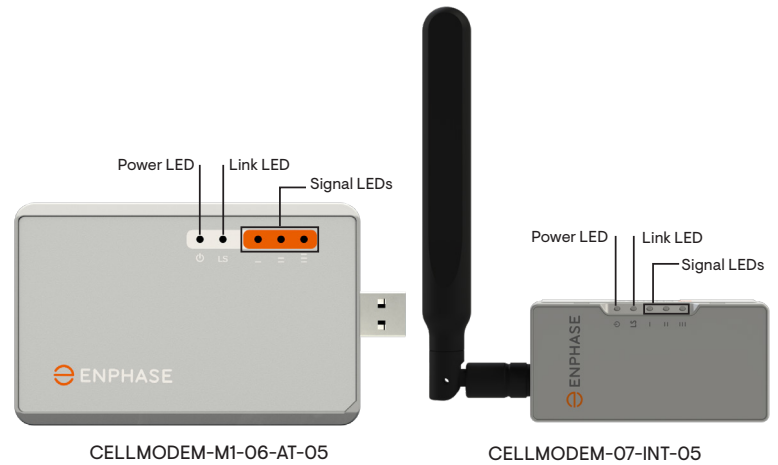

Check connection status and cellular signal strength

When the IQ System Controller establishes an internet connection, the IQ Gateway Network communications LED is solid green. You can use the Enphase Installer App to check the modem status and cellular signal strength. The IQ Gateway’s AP (Access Point) Wi-Fi network allows you to connect your mobile device (smartphone or tablet) to the IQ Gateway.

1. On the IQ Gateway, the AP mode LED is solid green when the AP mode is active. If the AP mode LED is not lit, press the AP mode button.
2. Launch the Enphase Installer App and tap connect to IQ Gateway.
3. Tap **Network**.
4. Under **Network Configuration**, tap **Cellular**. The app displays the connection status and an indication of signal strength.
5. Check the connection status and verify that signal strength is at least two bars for adequate data transmission.

LED status:

POWER LED	INDICATES
Off	DC power via USB is not present
On	DC power via USB present

LINK LED	INDICATES
Flashing slowly 	Searching for available network
Flashing slowly 	Idle
Flashing quickly 	Data transfer in progress

SIGNAL LEDs	DESCRIPTION	INDICATES
	All OFF	Very weak signal
	Bar 1 ON	Weak signal
	Bar 1 and 2 ON	Good signal
	Bar 1, 2, and 3 ON	Very good signal

Troubleshooting:

ISSUE	ACTION
No communication with the Enphase App after connecting the Cellular modem to the IQ Gateway.	<ol style="list-style-type: none"> 1. Disconnect the USB cable. 2. Reboot the IQ Gateway using the Enphase App or the Enphase Installer App. 3. Wait until the IQ Gateway boots completely. 4. Reconnect the Cellular modem USB cable.
I want to disconnect the modem and reuse it at a different site.	Moving the modem to a different IQ Gateway deactivates the modem. Contact Enphase Support if you need to reinstall the modem at a different site.

Safety

IMPORTANT SAFETY INSTRUCTIONS. SAVE THESE INSTRUCTIONS. This guide contains important instructions that you must follow during the installation and maintenance of the IQ System Controller 3 INT. Failing to follow any of these instructions may void the warranty (enphase.com/warranty).

In case of fire or other emergency

In all cases:

- If safe to do so, turn off all DC switches on each IQ Battery.
- Turn off the PV circuit breaker and battery circuit breakers inside the IQ System Controller 3 INT.
- Turn off the AC breaker (mains circuit breaker) for the IQ System Controller 3 INT circuit.
- If an isolator switch is present, switch off the AC isolator for the IQ System Controller 3 INT circuit.
- Contact the fire department or other required emergency response team.
- Evacuate the area.

In case of fire:

- When safe, use a fire extinguisher. Suitable types are A, B, and C dry chemical fire extinguishers. Additional extinguishing media include carbon dioxide or alcohol-resistant foams.



In case of flooding:

- Stay out of water if any part of the IQ System Controller 3 INT or wiring is submerged.
- If possible, protect the system by finding and stopping the source of the water and pumping it away.
- If water has contacted the unit, call your installer to arrange an inspection. If you are sure that water has never contacted the battery, let the area dry completely before use.







In case of unusual noise, smell, or smoke:















- Ensure nothing is in contact with the IQ System Controller 3 INT.
- Ventilate the room.
- Contact Enphase Support at <http://enphase.com/support>.

Safety and advisory symbols

-  **DANGER:** This indicates a hazardous situation, which, if not avoided, will result in death or serious injury.
-  **WARNING:** This indicates a situation where failure to follow instructions may be a safety hazard or cause equipment malfunction. Use extreme caution and follow instructions carefully.
-  **NOTE:** This indicates information particularly important for optimal system operation. Follow instructions carefully.

Safety instructions

-  **DANGER:** Risk of electric shock. Risk of fire. Only qualified electricians should install, troubleshoot, or replace the IQ System Controller 3 INT.
-  **DANGER:** Risk of electric shock. Risk of fire. Do not attempt to repair the IQ System Controller 3 INT. Tampering with or opening the IQ System Controller 3 INT will void the warranty. If the IQ System Controller 3 INT fails, contact Enphase Support for assistance at <http://enphase.com/support>.
-  **DANGER:** Risk of electric shock. Do not use Enphase equipment in a manner not specified by the manufacturer. Doing so may cause death or injury to persons or damage to equipment.
-  **DANGER:** Risk of electric shock. Do not install the IQ System Controller 3 INT without first removing AC power from the photovoltaic system and ensuring that the DC switch on the IQ Batteries is off. Disconnect the power coming from the photovoltaics and ensure that the DC switch on the IQ Batteries is off before servicing or installing.
-  **DANGER:** Risk of electric shock. Risk of fire. Do not work alone. Someone should be in the range of your voice or close enough to come to your aid when you work with or near electrical equipment.
-  **DANGER:** Risk of fire. Do not allow or place flammable, sparking, or explosive items near the IQ System Controller 3 INT.

-  **DANGER:** Risk of electric shock. In areas where flooding is possible, install the IQ System Controller 3 INT at a height that prevents water ingress.
-  **WARNING:** Risk of equipment damage. IQ System Controller 3 INT is shipped and stored on its back. The upright position is only needed when installed.
-  **WARNING:** You must install the IQ System Controller 3 INT only on a suitable wall using appropriate hardware.
-  **WARNING:** Before installing or using the IQ System Controller 3 INT, read all instructions and cautionary markings in this guide and on the equipment.
-  **WARNING:** Do not install or use the IQ System Controller 3 INT if it has been damaged in any way.
-  **WARNING:** Do not sit on, step on, place objects on, or insert objects into the IQ System Controller 3 INT.
-  **WARNING:** Do not place beverages or liquid containers on top of the IQ System Controller 3 INT. Do not expose the IQ System Controller 3 INT to flooding.
-  **NOTE:** Perform installation and wiring, including protection against lightning and resulting voltage surges, in accordance with all applicable local electrical codes and standards.
-  **NOTE:** Using unapproved attachments or accessories could result in damage or injury.
-  **NOTE:** Install properly rated over current protection as part of the system installation as per local standards and regulations.
-  **NOTE:** To ensure optimal reliability and to meet warranty requirements, the IQ System Controller 3 INT must be installed and/or stored according to the instructions in this guide and adhering to local standards and regulations.
-  **NOTE:** The IQ System Controller 3 INT is intended to operate with an internet connection through the built-in IQ Gateway. Failure to maintain an internet connection may have an impact on the warranty. See limited warranty for full terms and services (<http://enphase.com/warranty>).
-  **NOTE:** When replacing an IQ System Controller 3 INT, you must replace it with an IQ System Controller 3 INT of the same type with the same AC rating.
-  **NOTE:** Properly mount the IQ System Controller 3 INT. Ensure that the mounting location is structurally suited to bearing the weight of the IQ System Controller 3 INT.
-  **NOTE:** During use, storage, and transport, keep the IQ System Controller 3 INT:
 - Properly ventilated
 - Away from water, other liquids, heat, sparks, and direct sunlight
 - Away from excessive dust, corrosive and explosive gases, and oil smoke
 - Away from direct exposure to gas exhaust, such as from motor vehicles
 - Away from falling or moving objects, including motor vehicles. If mounted in the path of a motor vehicle, we recommend a 91 cm (36") minimum mounting height
 - In a location compliant with fire safety regulations
 - In a location compliant with local building codes and standards

Cellular modem safety warnings

 **WARNING:** This cellular device may cause interference with other electronic equipment if the equipment is inadequately protected.

 **WARNING:** Follow restrictions imposed for any environment in which the device may operate, such as fuel depots, chemical plants, or where blasting operations are in process.

Potential interference with pacemakers and other medical devices

Radiofrequency energy (RF) from cellular devices can interact with some electronic devices, causing electromagnetic interference (EMI). The FDA helped develop a detailed test method to measure EMI of implanted cardiac pacemakers and defibrillators from cellular devices. This test method is part of the Association for the Advancement of Medical Instrumentation (AAMI) standard. This standard allows manufacturers to ensure that cardiac pacemakers and defibrillators are safe from cellular device EMI. The FDA continues to monitor cellular devices for interactions with other medical devices. If harmful interference occurs, the FDA will assess the interference and work to resolve the problem.

Precautions for pacemaker wearers

EMI can affect a pacemaker in one of three ways:

- Stop the pacemaker from delivering the stimulating pulses that regulate the heart's rhythm.
- Cause the pacemaker to deliver the pulses irregularly.
- Cause the pacemaker to ignore the heart's rhythm and deliver pulses at a fixed rate.

Based on current research, cellular devices do not pose a significant health problem for most pacemaker wearers. However, people with pacemakers may want to take simple precautions to avoid EMI from cellular devices:

- Keep the device on the opposite side of the body from the pacemaker to add extra distance between the pacemaker and the device.
- Avoid placing a turned-on device next to the pacemaker (for example, don't carry the device in a shirt or jacket pocket directly over the pacemaker).

Cellular modem terms and conditions

These following Cellular modem Terms and Conditions ("Terms and Conditions") will apply to anyone who purchases and/or uses ("you", "your") the Cellular modem to enable internet connectivity for an IQ Gateway device ("Cellular modem Terms"). These Cellular modem Terms are incorporated into and made an integral part of the Agreement.

1. **Cellular modem description, use, unauthorized use limitation on use.** The Cellular modem must be used only in conjunction with Enphase's IQ Gateway/IQ Combiner products. The Cellular modem shall not be used for any unlawful purpose(s).
2. **Limited Warranty.** The Cellular modem comes with and is covered by a 5-year Limited Warranty which is included in the standard Enphase Limited Warranty which can be found at <http://www.enphase.com/warranty> ("Limited Warranty"). Except as expressly provided in this Section, to the maximum extent permitted by applicable law, the Cellular modem is provided on an "AS IS" basis without warranty whatsoever, and Enphase expressly disclaims all warranties, express, implied, and statutory including the implied warranties of merchantability, satisfactory quality, fitness for a particular purpose, title, and non-infringement. Any use of the Cellular modem other than as expressly stated in these Terms and Conditions shall constitute a breach of the limited warranty and render it null and void. The Cellular modem will contain a SIM card provided by a network provider. The SIM card (a) must not be removed from the Cellular modem, nor (b) used with any other device. Any such removal or use shall constitute a breach of the Limited Warranty and render the Limited Warranty null and void.
3. **Territory.** The Cellular modem shall only be used in the countries listed on this quick installation guide (QIG). Enphase, in its sole discretion, reserves the right to amend the QIG to add or delete counties wherein the Cellular modem may be used.

4. **Network coverage.** Network Coverage is dependent upon network availability, which is the responsibility of the network service provider. **Enphase shall have no responsibility, nor any liability to any end-user for the network service provider's non-coverage, lack of coverage, defective coverage, or termination of the coverage.**
5. **Connectivity.** Cellular modem connectivity is subject to the telecommunication regulations and policies and terms of the network service providers, and the applicable laws of the country in which the Cellular modem is located and installed. **Enphase makes no representation or warranties as to such connectivity and Enphase shall have no responsibility, nor any liability to you for the network service provider's failure to provide connectivity nor any responsibility or liability due to the network service provider's termination of connectivity.**
6. **Acceptable Use Policy.** You must conform to the applicable acceptable use policy ("AUP") posted on the applicable network provider's website, and you alone will be responsible for ensuring compliance with its terms. You will indemnify, defend, and hold Enphase harmless against any claims or losses suffered by Enphase as a result of your breach of the AUP.

EMC, Safety, and R&TTE Directive Compliance for cellular modem

The CE mark is affixed to the cellular modem to confirm compliance with the following European Community Directives:

Council Directive 2004/108/EC of 15 December 2004 on the approximation of the laws of Member States relating to electromagnetic compatibility; and Council Directive 2006/95/EC of 12 December 2006 on the harmonization of the laws of Member States relating to electrical equipment designed for use within certain voltage limits; and Council Directive 2011/65/EU on the restriction of the use of certain hazardous substances in electrical and electronic equipment; and Council Directive 1999/5/EC of 9 March 1999 on radio equipment and telecommunications terminal equipment and the mutual recognition of their conformity.

For Cellular modems with:

AT&T connectivity – The terms are available at <https://www.att.com/legal/terms.aup.html> and shall apply.

T-Mobile connectivity – The terms are available at <https://www.t-mobile.com> and shall apply.

Manufacturer:

Enphase Energy Inc.,
47281 Bayside Pkwy.,
Fremont, CA, 94538,
United States of
America
PH: +1 (707) 763-4784

APAC importer:

Enphase Energy Aust.
Pty/Ltd.,
88 Market St.,
South Melbourne, VIC
3205
PH: +61 3 86691679

Europe importer:

Enphase Energy NL B.V.,
Het Zuiderkruis 65,
5215MV, 's-Hertogenbosch,
The Netherlands,
PH: +31 73 3035859

Assembled in China



Environmental protection

ELECTRONIC DEVICE: DO NOT THROW AWAY. Waste electrical products should not be disposed of with household waste. Refer to your local codes for disposal requirements.

Limitation of use

Your IQ System Controller 3 INT and IQ Battery 5P units are not intended for use as a primary or backup power source for life-support systems, other medical equipment, or any other use where product failure could lead to injury, loss of life, or catastrophic property damage. Enphase disclaims any and all liability arising out of any such use of your IQ System Controller 3 INT and IQ Battery 5P units. Further, Enphase reserves the right to refuse to provide support in connection with any such use and disclaims any and all liability arising out of Enphase's provision of, or refusal to provide, support for your IQ System Controller 3 INT/IQ Battery 5P device in such circumstances.

Wiring scenarios

APPLICABLE REGIONS	WIRING SCENARIOS	GRID NEUTRAL DISCONNECTION IN BACKUP MODE	NEUTRAL CIRCUIT BREAKER REQUIRED	COMPATIBLE BATTERY MODEL	WIRING SCENARIO DESTINATION
UK	Single-phase system	No	No	IQBATTERY-5P-1P-INT/ IQBATTERY-5P-3P-INT	A1
Europe (2-pole breaker)	Single-phase system	Yes	Yes	IQBATTERY-5P-1P-INT	A2
Europe (3-pole breaker)	Three-phase grid/ mains and loads	Yes	No	IQBATTERY-5P-3P-INT	A3
	Three-phase PV and Battery	Yes	No	IQBATTERY-5P-3P-INT	A4
Europe (4-pole breaker)	Three-phase grid/ mains and loads	Yes	Yes	IQBATTERY-5P-3P-INT	A5
	Three-phase PV and Battery	Yes	Yes	IQBATTERY-5P-3P-INT	A6

Single-phase home

A1: System with single-phase IQ Battery and PV without neutral disconnection.

NOTE:
An RCBO can be used in place of an RCD and MCB for PV and IQ Battery circuits. When using an RCBO, IQ Battery, and PV require separate RCBO.

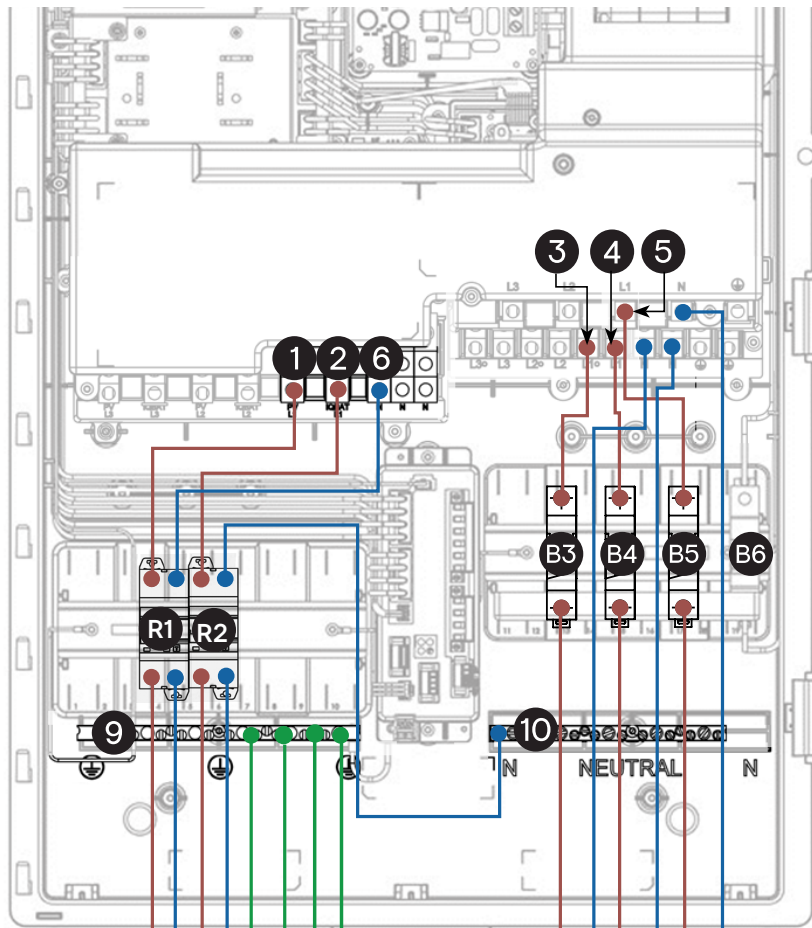

- 1 PV L1 terminal
- 2 IQ Battery L1 terminal
- 3 Grid/Mains L1 terminal
- 4 Non-backup loads L1 terminal
- 5 Backup loads L1 terminal
- 6 PV neutral terminal
- 9 Earth bar
- 10 Neutral bar/Terminal for battery neutral connection
- B1 PV circuit breaker
- B2 IQ Battery circuit breaker
- B3 Mains circuit breaker
- B4 Non-backup circuit breaker
- B5 Backup circuit breaker
- B6 IQ Gateway circuit breaker (pre-installed and pre-wired)

Legends

- L1
- Neutral
- Protective earth (PE)

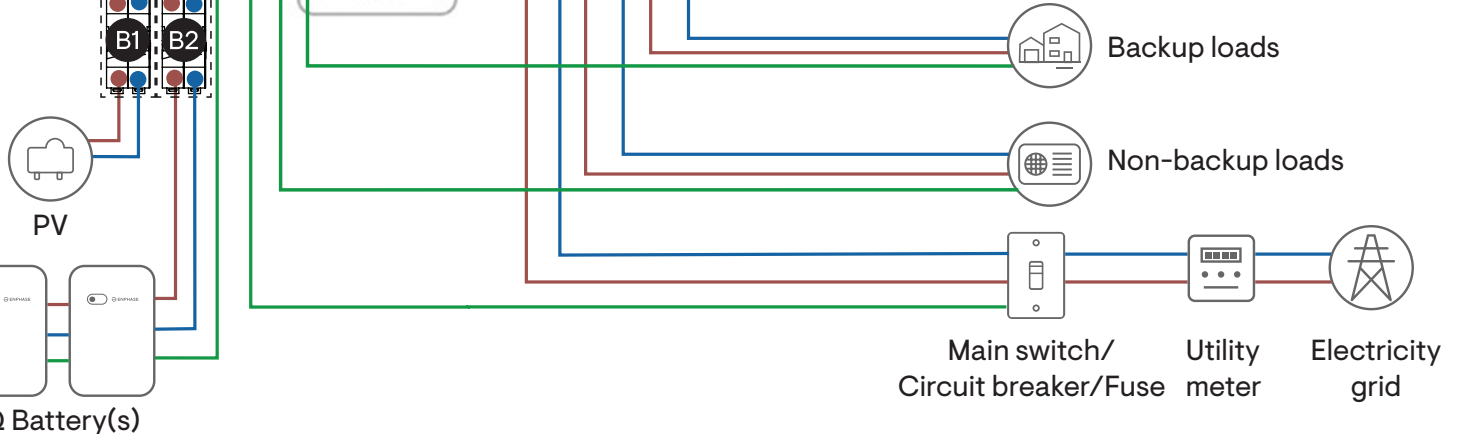

Single-phase home

A2: System with single-phase IQ Battery and PV with neutral disconnection and neutral circuit breakers.

NOTE:
An RCBO can be used in place of an RCD and MCB for PV and IQ Battery circuits. When using an RCBO, IQ Battery, and PV require separate RCBO.

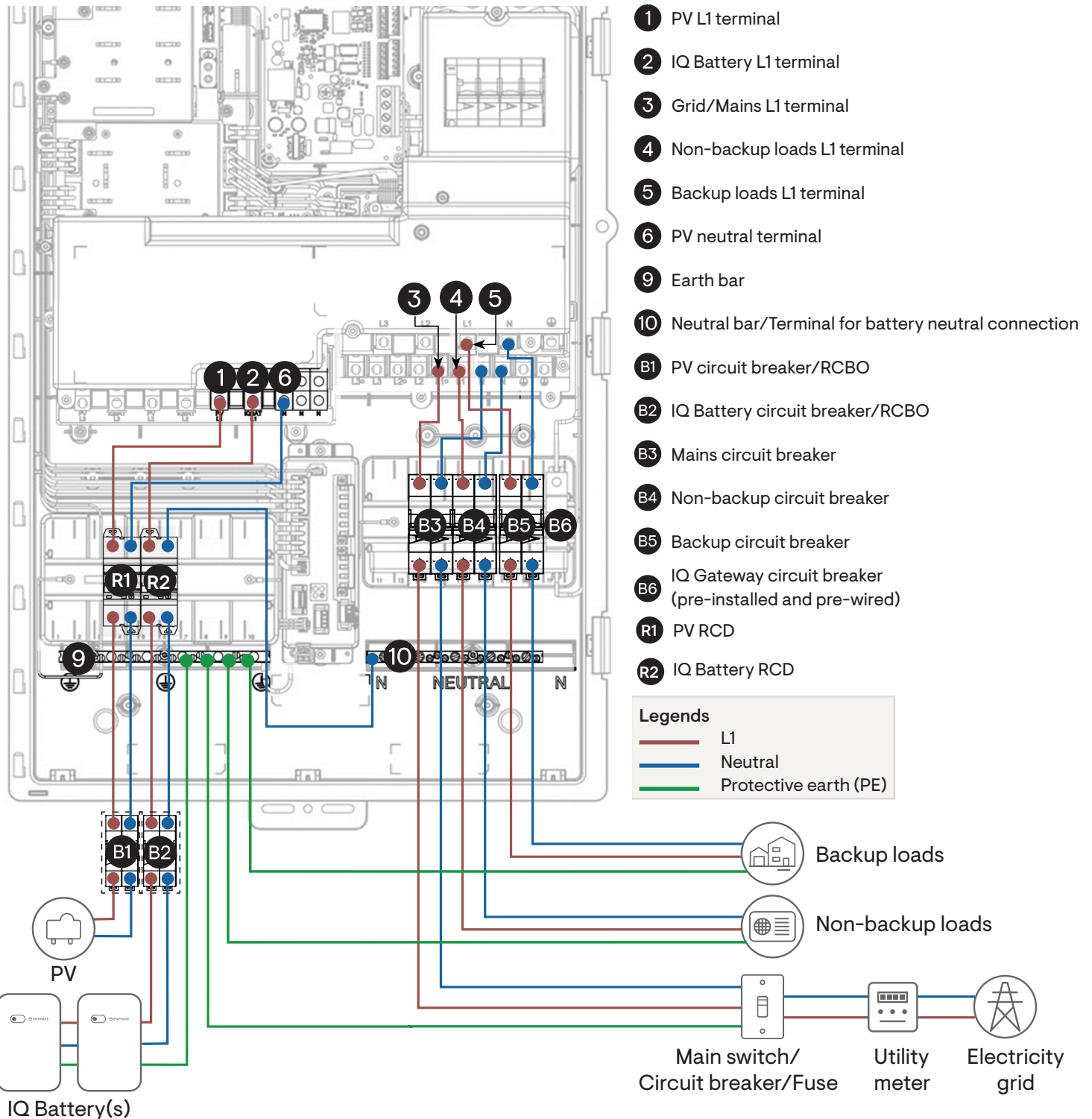

Three-phase home

A3: Grid/mains and loads without neutral circuit breaker and with neutral switching.

NOTE: For system safety, installing an RCD is mandatory in the backup circuit.

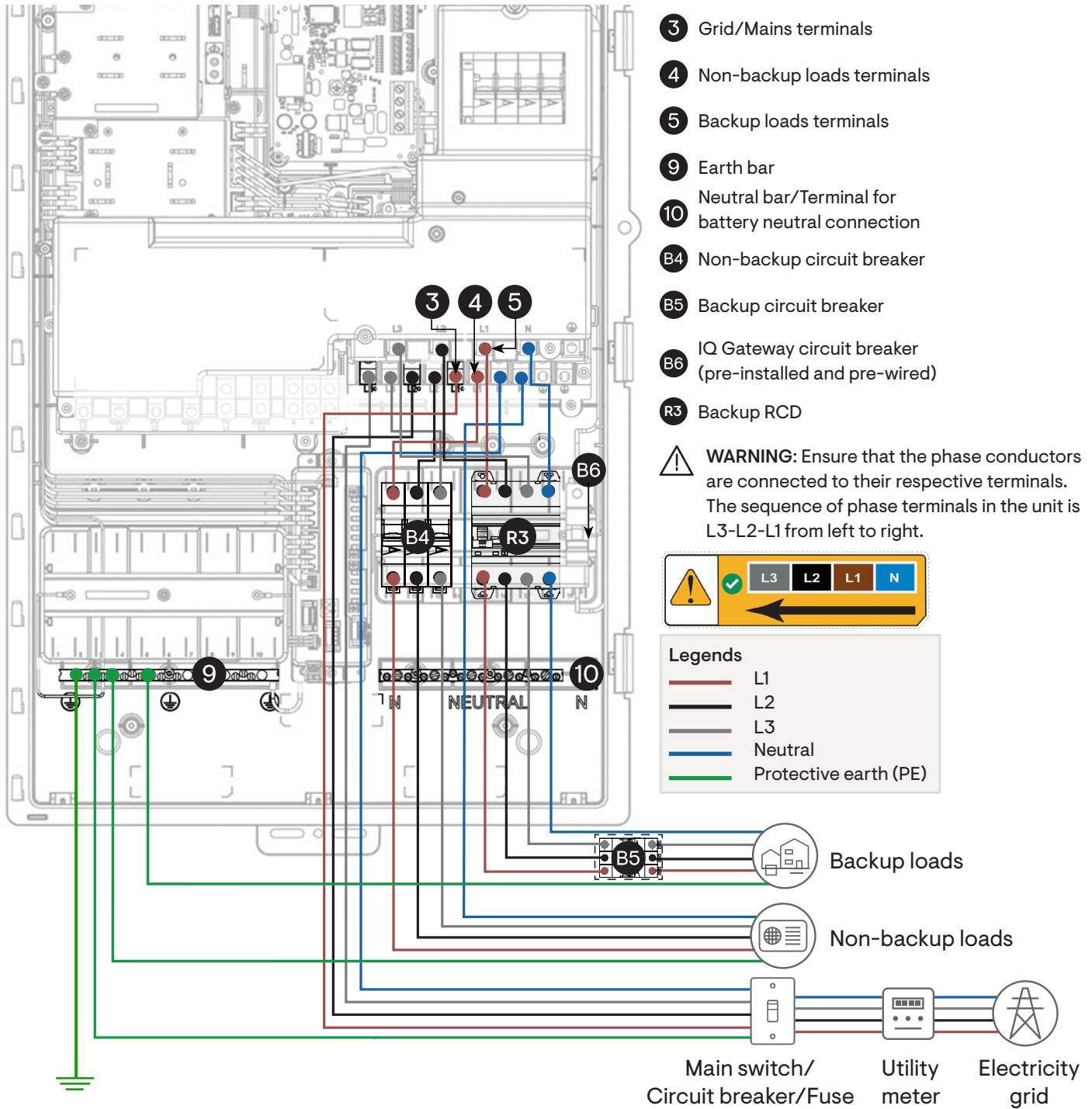

NOTE: If required by local regulations, the earth bar in the IQ System Controller must be connected to the building's earth with a single-core cable of at least 10 mm² copper cross-section and with green/yellow insulation.

Three-phase home

A4: Three-phase PV and IQ Battery.

NOTE:
An RCBO can be used in place of an RCD and MCB for PV and IQ Battery circuits. When using an RCBO, IQ Battery and PV require separate RCBO.

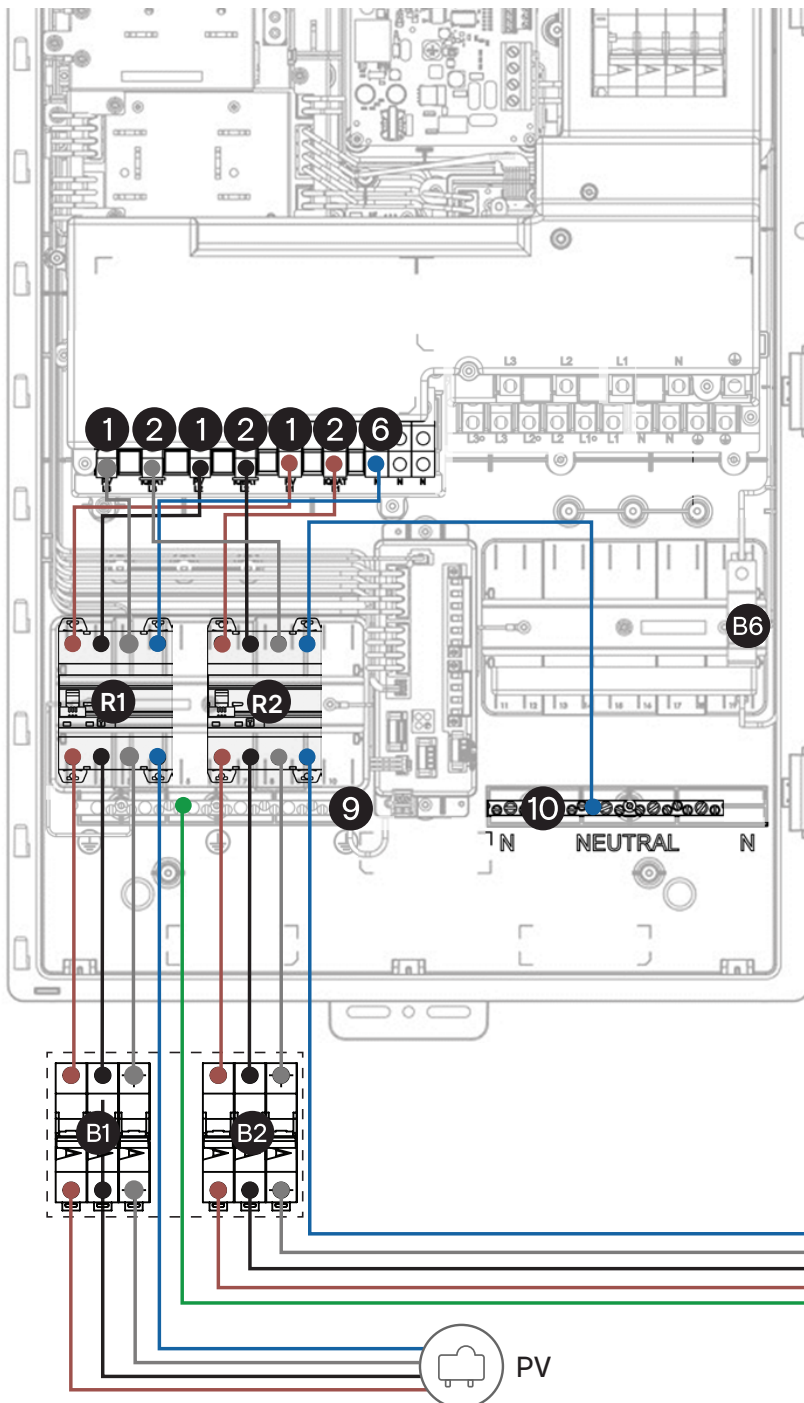

- 1 PV terminals
- 2 IQ Battery terminals
- 6 PV neutral terminal
- 9 Earth bar
- 10 Neutral bar/Terminal for battery neutral connection
- B1 PV circuit breaker
- B2 IQ Battery circuit breaker
- B6 IQ Gateway circuit breaker (pre-installed and pre-wired)
- R1 PV RCD
- R2 IQ Battery RCD

WARNING: Ensure that the phase conductors are connected to their respective terminals. The sequence of phase terminals in the unit is L3-L2-L1 from left to right.



Legends

—	L1
—	L2
—	L3
—	Neutral
—	Protective earth (PE)

IQ Battery

PV

Appendix A - Wiring scenarios

Applicable region:
Europe (4-pole breaker)

Three-phase home

A5: Grid/mains and loads without neutral circuit breaker and with neutral switching.

NOTE:
For system safety, installing an RCD is mandatory in the backup circuit.

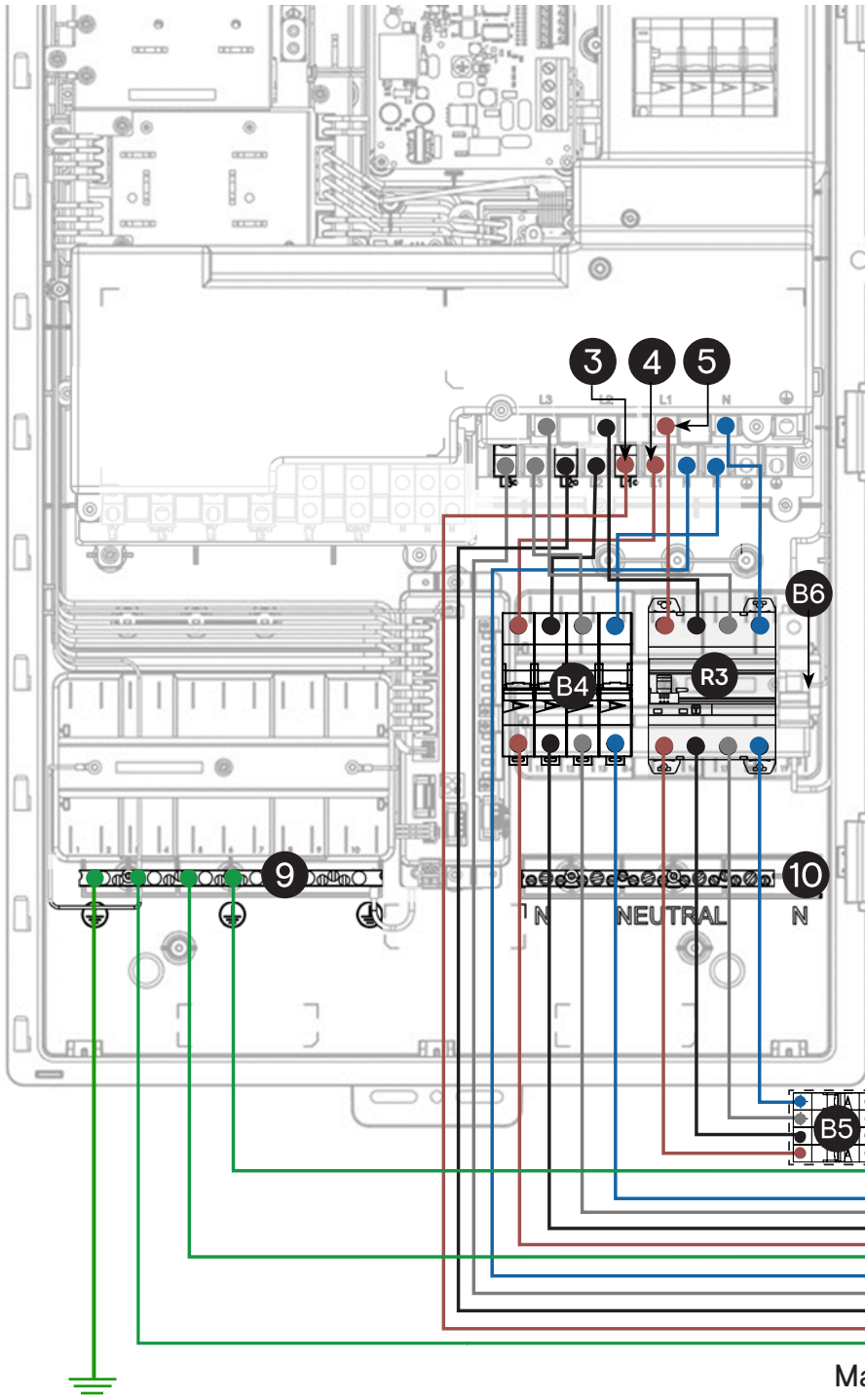

- 3 Grid/Mains terminals
- 4 Non-backup loads terminals
- 5 Backup loads terminals
- 9 Earth bar
- 10 Neutral bar/Terminal for battery neutral connection
- B4 Non-backup circuit breaker
- B5 Backup circuit breaker
- B6 IQ Gateway circuit breaker (pre-installed and pre-wired)
- R3 Backup RCD

WARNING: Ensure that the phase conductors are connected to their respective terminals. The sequence of phase terminals in the unit is L3-L2-L1 from left to right.



Legends	
—	L1
—	L2
—	L3
—	Neutral
—	Protective earth (PE)

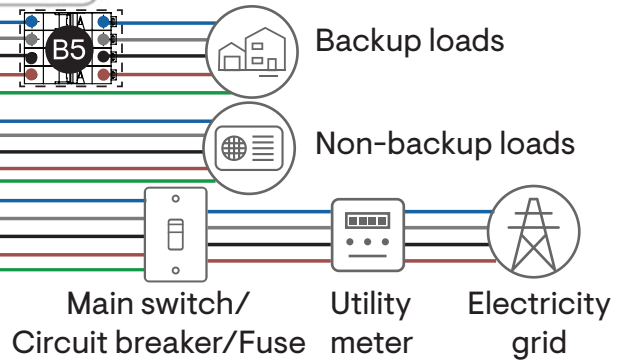

NOTE:
If required by local regulations, the earth bar in the IQ System Controller must be connected to the building's earth with a single-core cable of at least 10 mm² copper cross-section and with green/yellow insulation.

Three-phase home

A6: Three-phase PV and IQ Battery.

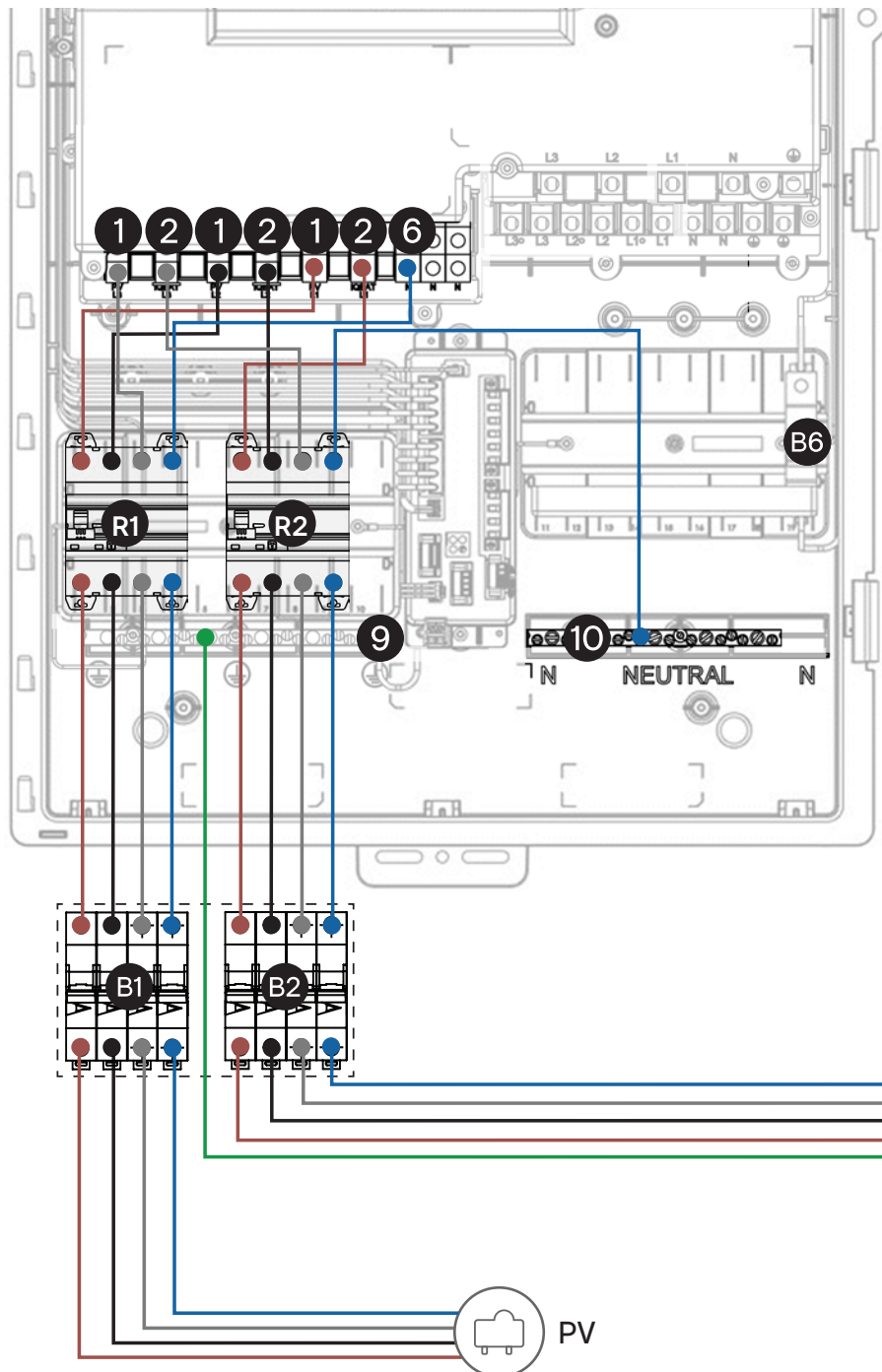

✓ NOTE: An RCBO can be used in place of an RCD and MCB for PV and IQ Battery circuits. When using an RCBO, IQ Battery and PV require separate RCBO.

- 1 PV terminals
- 2 IQ Battery terminals
- 6 PV neutral terminal
- 9 Earth bar
- 10 Neutral bar/Terminal for battery neutral connection
- B1 PV circuit breaker
- B2 IQ Battery circuit breaker
- B6 IQ Gateway circuit breaker (pre-installed and pre-wired)
- R1 PV RCD
- R2 IQ Battery RCD

⚠ **WARNING:** Ensure that the phase conductors are connected to their respective terminals. The sequence of phase terminals in the unit is L3-L2-L1 from left to right.



Legends	
—	L1
—	L2
—	L3
—	Neutral
—	Protective earth (PE)

Revision history

REVISION	DATE	DESCRIPTION
140-00428-01	May 2025	Initial release.

Installer notes

Installer notes

Installer notes



EN - IQ System Controller 3 INT installation checklist

Checks to be done before powering up the IQ System Controller (ensure to follow local regulations)

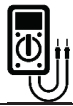
1	<input type="checkbox"/>	Earthing: Ensure that a local earth is present and connected to the earth bar in system controller.
2	<input type="checkbox"/>	Checks: Clean any debris inside, torque the terminals, and ensure that all circuit breakers are OFF.
3	<input type="checkbox"/>	Grid supply phase sequence: Connect the grid cable to the grid/mains terminals in the IQ System Controller per the label and verify that the phase rotation is Right/clockwise.
4	<input type="checkbox"/>	Grid supply neutral: Connect the grid neutral cable to the grid/mains neutral terminal.
5	<input type="checkbox"/>	Non-backup loads: Connect the non-backup load cables to non-backup terminals per the label.
6	<input type="checkbox"/>	Backup loads (based on battery type): Install an RCD for backup loads in the system controller. <ul style="list-style-type: none"> IQBATTERY-5P-1P-INT/ROW: Connect the backup load cables to the L1 backup terminal. IQBATTERY-5P-3P-INT: Connect the backup load cables to the backup terminals per the label.
7	<input type="checkbox"/>	Backup loads neutral: Ensure neutrals of backup loads are separated in the main panel and connected to the backup load neutral terminal in the IQ System Controller.
8	<input type="checkbox"/>	No battery/PV-only site: Connect the load cables to the non-backup terminals per the label.
9	<input type="checkbox"/>	PV neutral: Connect the PV neutral cable to the PV neutral terminal.
10	<input type="checkbox"/>	IQ Battery neutral: Connect the IQ Battery neutral cable to the neutral bar.
11	<input type="checkbox"/>	System Shutdown Switch (SSD): Ensure that the SSD is wired, and connected to the SSD terminal on the input-output board (IOB), and verify that the switch is in the ON position.
12	<input type="checkbox"/>	Manual override switch (MOR): The MOR switch must be in the OFF/down position.
13	<input type="checkbox"/>	Control wiring: Terminate the drain wire of the control wiring at one end of each wiring section.
14	<input type="checkbox"/>	Grid voltage measurement: On the grid side of the main circuit breaker, verify that L-N voltages are 230 V _{rms} (±8%) across the three phases. Note down the voltages below.
		<div style="display: flex; justify-content: space-around; align-items: center;"> <div style="text-align: center;">● L1-N: <input type="text"/> V</div> <div style="text-align: center;">● L2-N: <input type="text"/> V</div> <div style="text-align: center;">● L3-N: <input type="text"/> V</div> <div style="text-align: center;">● N-PE: <input type="text"/> V</div> </div>
15	<input type="checkbox"/>	Mains phase rotation: Use a phase rotation meter to ensure L1-L2-L3 terminals have a Right (R)/clockwise phase rotation. Swap L2 and L3 wires if the phase rotation is incorrect.
16	<input type="checkbox"/>	Additional test: Complete checks as per local regulation including but not limited to earth measurements, and isolation testing before powering ON the system controller.

Checks to be done after powering up the IQ System Controller

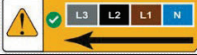
1	<input type="checkbox"/>	Energizing system controller: Close the mains circuit breaker and wait for the relay closure in the system controller. Listen for the “click” sound and verify that the system controller LEDs are ON.
2	<input type="checkbox"/>	Error check: If the IQ System Controller does not power on, then repeat steps 1-4 (from the first table). If the relays do not close, then repeat steps 14-16.
3	<input type="checkbox"/>	Voltage/Phase rotation check: Use a phase rotation meter to check voltage and phase rotation on the grid/mains terminals in the system controller. L-N voltages should be at 230 V _{rms} (±8%). The phase rotation should be right/clockwise.
		<div style="text-align: center;">  </div> <div style="display: flex; justify-content: space-around; align-items: center;"> <div style="text-align: center;">● L1-N: <input type="text"/> V</div> <div style="text-align: center;">● L2-N: <input type="text"/> V</div> <div style="text-align: center;">● L3-N: <input type="text"/> V</div> <div style="text-align: center;">● N-PE: <input type="text"/> V</div> </div>
4	<input type="checkbox"/>	Circuit breakers: Turn ON PV, IQ Battery, backup loads, and non-backup loads circuit breakers.
5	<input type="checkbox"/>	Photo: Take pictures of the IQ System Controller 3 INT without the dead front and the checklist once completed. This is a mandatory step during Enphase Installer App (ITK) commissioning.
6	<input type="checkbox"/>	Additional test: Complete checks as per local regulation including but not limited to loop impedance, line impedance, and backup load RCD tests before completing the commissioning.
7	<input type="checkbox"/>	Dead front: Attach the dead front and add the breaker filler plate on the mains side.
8	<input type="checkbox"/>	Cell modem cable: Connect to the USB port of the IQ Gateway.

Date

Installer name

Installer company

Installer signature



NOTE: This checklist covers key points from the quick install guide. Additional checks per local regulations and electrical practices should be completed before powering up the IQ System Controller.

IQSC 3 INT 140-00428-01- EN-INT 2025-05-02

© 2025 Enphase Energy. All rights reserved. Enphase, the e and CC logos, IQ, and certain other marks listed at <https://enphase.com/trademark-usage-guidelines> are trademarks of Enphase Energy, Inc. in the U.S. and other countries. Data subject to change.

